

Assembly Manual



Patent 6468233

Key Benefits

- ◆ Quantitate posture curves
- ◆ Monitor patient progress
- ◆ Measure postural lean (forward/negative)
- ◆ Facilitate patient understanding and compliance
- ◆ Provide documentation for referral sources and third party .

Distributed by Pneumex, Inc.

Protocols by PneuThera

Pneumex, PneuGait Foot Strap, PneuMAP, PneuBack Chair, PneuWeight and PneuVest are trademarks of Pneumex, Inc.

Copyright 2003 Pneumex

All rights reserved

Visit our web site at

www.Pneumex.com

Pneumex, Inc.
2605 North Boyer Ave.
Sandpoint, ID 83864
Phone 208-265-4105
Fax 208-265-9651
E-mail pneumex@pneumex.com

Rev 014

Revised Feb 21-2014

Genuine Pneumex Equipment

Contents

Preface	4
Liability Notice	4
Description and Use	5
Components	5
Parts	6
Using the PneuMAP	7
How to read a screening	10
MAP Grid X & Y	11
Five Areas of Screening	12
Four Posture Types	13
Posture Simulator	14
Measuring Scoliosis	15
MAP Assembly	19
Upright Post & Grid	20
Grid Height	21
Maintenance	22
Specifications	22
Troubleshooting	22
Your Warranty	23

Preface

This manual contains the operating instructions and service requirements for the PneuMAP Posture measuring. The manual is designed for use by clinical staff use and it is expected that the clinicians will instruct their patients and clients in the proper use of the system and its accessories. Please read the manual carefully before using the PneuMAP.

Liability Notice

Failure to follow the conditions set forth below shall absolve Pneumex, Inc. from any responsibility for the safety, reliability, and performance of this equipment.

Each operator must read the operator manual in full before using the product for the first time.

Each independent user must be instructed in the proper use of the system and its accessories.

It is suggested operators of PneuMAP Stations receive approved training and certification from Pneumex, Inc. or their designee before operating the equipment. Please call Pneumex at 800-447-5792 to find out more about our training and certification programs.

Description and Use

Accurately shows posture deficiencies. This posture gauge graphically measures the posture curves and lean. The graphing is done with the patient standing in front of the PneuMAP. Both the patient and the clinician can see how the patients posture compares to the ideal posture. The PneuMAP provides simple diagnosis and documentation. The MAP can be used for measuring AP postural curves in standing and sitting postures as well as ROM of the thoracic spine and also for measuring lateral curves such as scoliosis. A recent study done at the University of Montana has shown a high correlation when comparing the Map's ability to measure a Scoliotic curve and X-rays of a Scoliotic curve.

Components

The PneuMAP components include a frame with a grid and a stylus to follow the curve of the back and take appropriate measurements. These measurements are entered into a software program provided with the MAP that translate the measurements into a graphic print out of the clients posture.

Each PneuMAP comes with:

- Installation hardware
- Operator/service manual
- Posture simulator
- MAP Accessories
- Scoliosis Tracing Unit

To order accessories Phone 1-800-447-5792

Parts

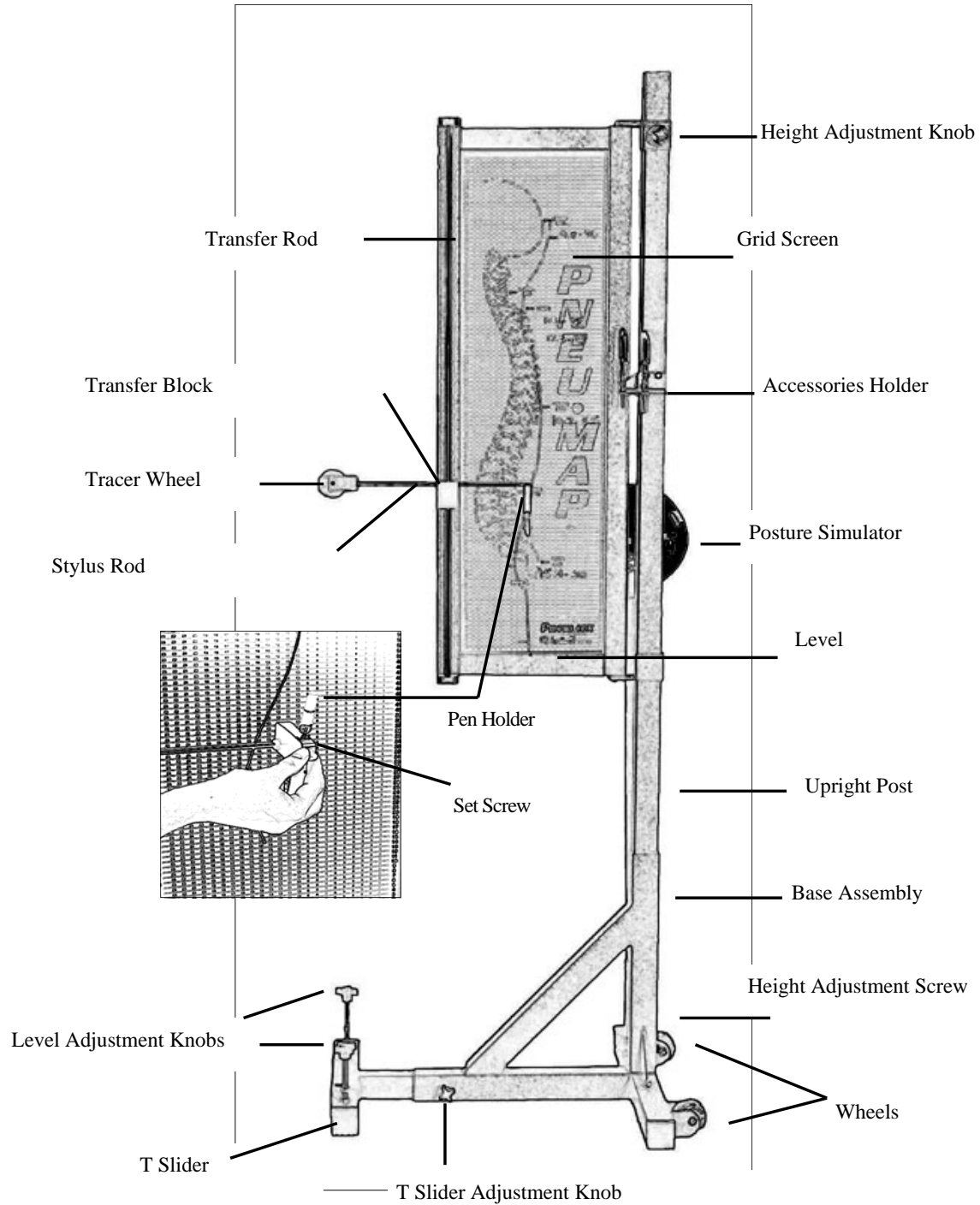

Using the PneuMAP™

The PneuMAP accurately shows postural deficiencies. This posture gauge graphically measures the postural curves and lean. The graphing is done with the patient standing in front of the PneuMAP. Both the patient and the clinician can see how the patient's posture compares to an ideal posture.

Ideally, patients should be in a gown so that the stylus can run right down the spinous processes. However, if you are doing screenings over clothes, you should have the patient remove their shoes, belt and bulky clothing.

1. Level MAP before beginning screening. Use Horizontal and vertical adjustment knobs to level MAP.
2. Place pen in the stylus, pushing the pen all the way in, tighten the screw.
3. Stand the patient in front of the MAP with heels lined up on the arrows against the base.
4. Adjust the height of the frame so that the wheel reaches the sacrum when it is at the bottom of the MA. (If the frame is adjusted too high or low, you will not get a full length reading.)

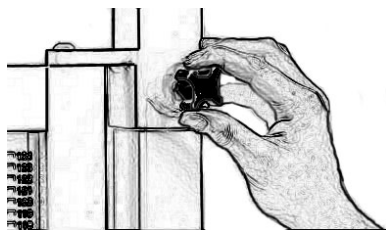
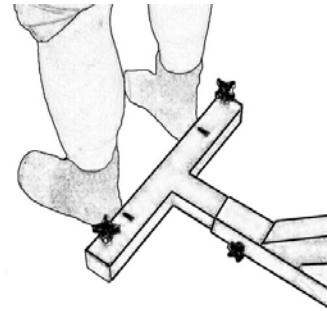

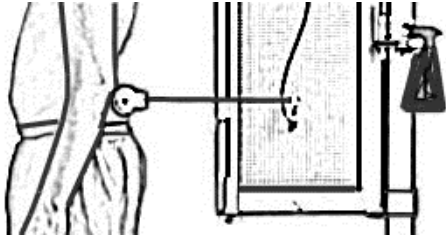

5. Line the patient up so that the tracer wheel is on the spinous processes. Find this position at the center of the lumbar curve. (The wheel must run directly down the spinous processes in order to get a correct reading.) Practice running the wheel down the patients lumbar area, so they get used to the feel before doing the official screening.

NOTE Do not touch the back of the patient's head until you start tracing. The wheel and your finger should touch at the same time

6. Prior to the screening, ask the patient to take a deep breath, place their hands at their sides, relax, stand normally and focus on a point directly in front of them

It helps to have something specific on the wall for them to focus on

7. Just before you run the screening, tell the patient, "I'm going to place my finger on your forehead", so you can tell if they move either forward or backward during the tracing.

8. Move the tracer wheel from the lumbar to the patient's cranial apex. Do not touch their head with the tracer wheel until you are ready to begin mapping. If the wheel is off the center of the head, check the patient for scoliosis.*

***NOTE If the wheel goes off center, the patient probably has SCOLIOSIS or a lateral shift. Refer to the Scoliosis section**

9. With your thumb and index finger on the wheel block, run the wheel, with a light, constant pressure, down the center of the patient's spine. Start at the cranial apex and run down to the sacrum. (The stylus on the other end of the bar should be tracing the contours of the spine.) Find the sacral apex, place the wheel at the sacral apex and mark it on the screen.

When taking the readings, always:

Stand directly in front of the line

Put mark on the left side of the line

Read from the right side of the line.



You should now have a two-dimensional posture screening on the MAP grid.

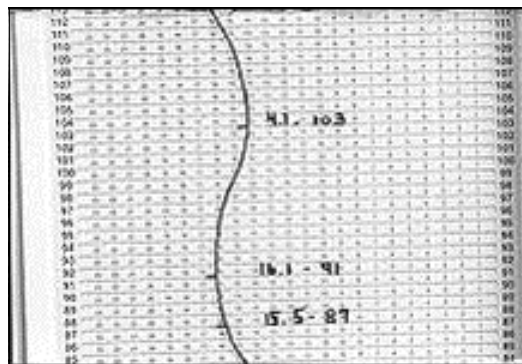

How to Read a Screening

Begin by locating the following 6 points:

- cranial apex
- cervical apex (approx. C₄)
- four lines down from cervical apex (approx. C₇)
- thoracic apex
- lumbar apex
- sacral apex

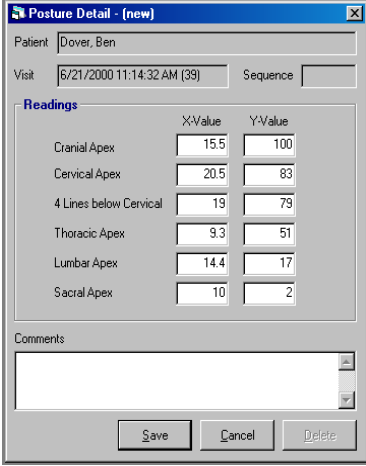

The screenshot shows a software window titled "Posture Detail - (new)". It contains a patient name field "Dover, Ben", a visit date "6/21/2000 11:14:32 AM (39)", and a sequence field. Below this is a "Readings" section with a table of X-Value and Y-Value for six points. At the bottom, there is a "Comments" text area and three buttons: "Save", "Cancel", and "Delete".

	X-Value	Y-Value
Cranial Apex	15.5	100
Cervical Apex	20.5	83
4 Lines below Cervical	19	79
Thoracic Apex	9.3	51
Lumbar Apex	14.4	17
Sacral Apex	10	2

The apex is the furthest point of each curve.

If the apex seems to cover more than one point, pick the center point. For example: if 115, 116, and 117 are all at 6.0 which is the furthest point of the curve, choose 116 at 6.0 to enter in the computer. If 115, 116, 117 and 118 are all the same, making the mid-point 116 1/2, take the lower number as your reading, thus you would chose 116 in this example.

If you have two points that are the same, choose the lower of the two. One exception: if the cervical apex covers more than one point, choose the point that is 4 lines up from the C₇ transition point. To find the sacral apex, palpate the most prominent point before letting the patient move. Place the wheel on that point and make a mark on the M.A.P. grid.

Enter the points in the Posture Screening Detail Window For each point, you should have a horizontal (x value) and vertical (y value) reading.

Detailed information on using the MAP software is in the Analysis Instruction booklet that came with your software.

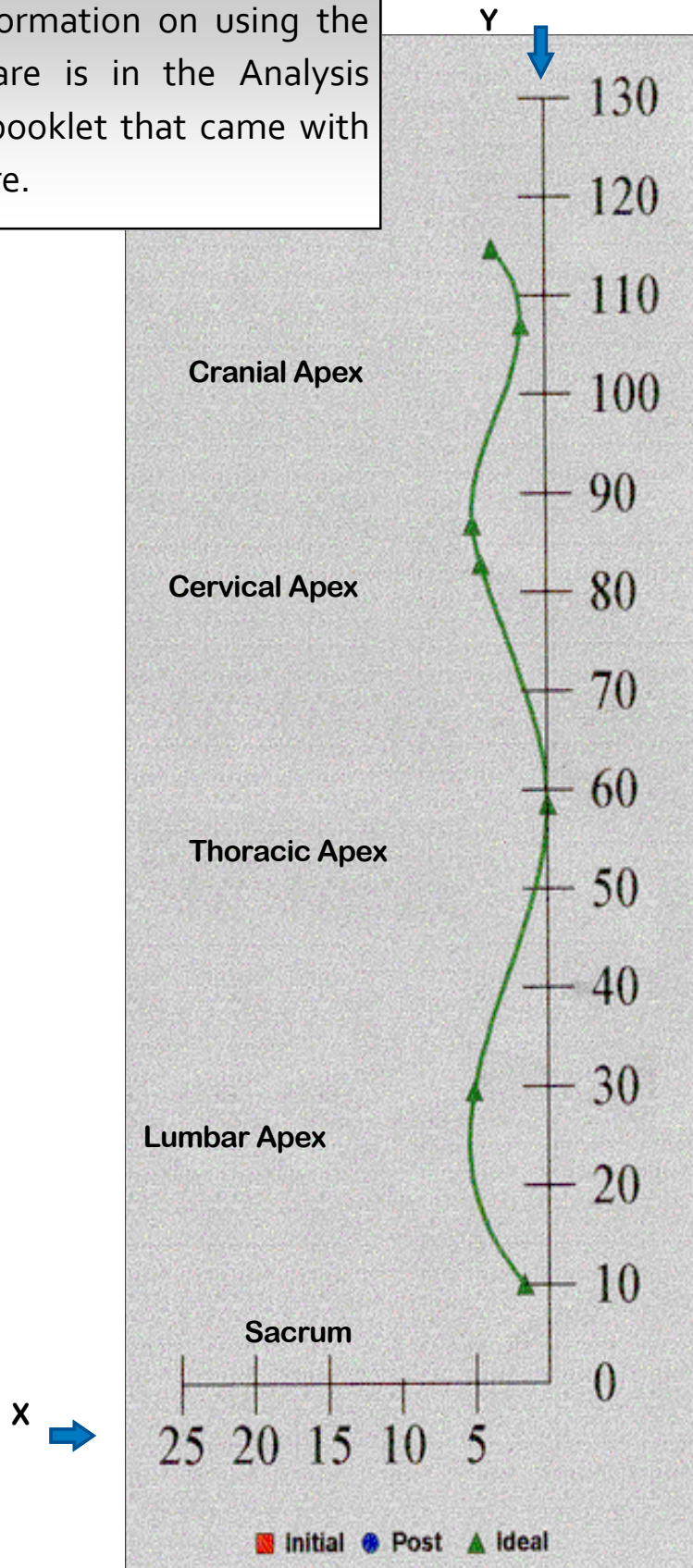

Five Areas

There are five areas of focus when reviewing a postural screening. The first four numbers represent the rise to run of each curve.

Curvature	Minimal	Normal	Excessive
Cervical	< 7	7-13	>13
Upper Thoracic	< 8	8-12	>12
Lower Thoracic	< 8	8-12	>12
Lumbar	< 8	8-12	>12

The relative normal posture on the graph equates to values of 10 cervical, upper thoracic, lower thoracic and lumbar with a lean of zero degrees. Numbers greater than 10 indicate a greater curve than the norm, while less than 10 indicates less curvature than the norm.

The fifth number represent the patients lean, which is the degree of lean from their lumbar apex to cervical apex.

Lean	Neutral	Anterior	Posterior
	between -1 and 2	> 2	< -1

Note: Our primary concern with these numbers is not that they all be 10's, but that they be in balance with each other.

The number 10 was randomly chosen to be the norm. An anchor point was needed to provide a standard point of reference, it could have been any number.

Four General Posture Types

Type I

Forward Lean
Excessive Upper Thoracic Curvature

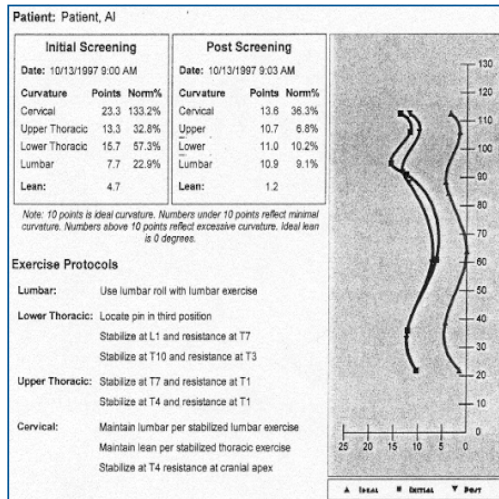

Type II

Forward Lean
Excessive Lumbar Curvature

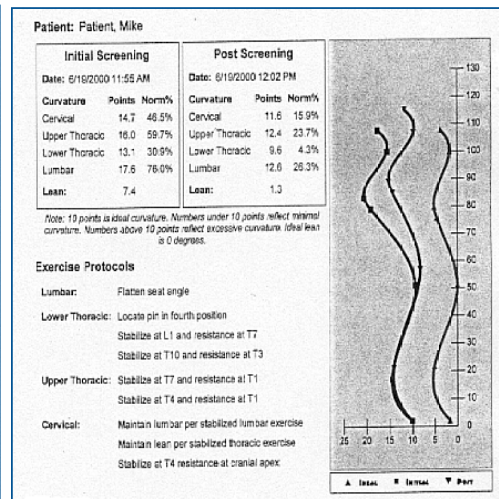

Type III

Normal/Excessive Forward Lean
Minimal Thoracic Curvature
Minimal Lumbar Curvature

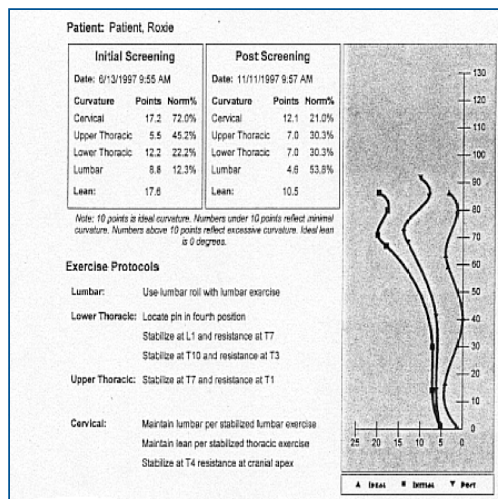

Type IV

Reverse Lean

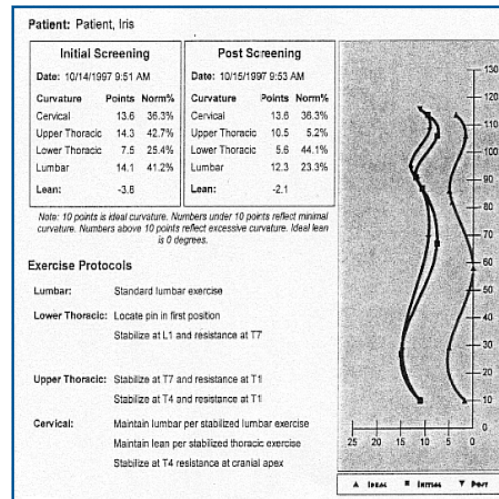

Note: Any of these 4 types could have either an excessive or a flat cervical curve. Clinicians have found that a flat cervical curve shows referral to wrist and arm impingements. An excessive cervical curve often shows referral to upper thoracic, shoulder and chronic headaches. Patients who have experienced injury in accidents often have good posture. We have found these patients to be very weak.

Posture Simulator

Use the Posture Simulator (8 - 10 lb. bowling ball on a stick) to demonstrate lean to a patient . Have the patient hold the stick in one hand at the height of their lumbar apex. The bowling ball should be head high. Have them tilt the ball forward, feeling the extra pressure it causes on their wrist. Improper posture causes a similar effect on the patients spine causing it to work harder to compensate for improper posture.

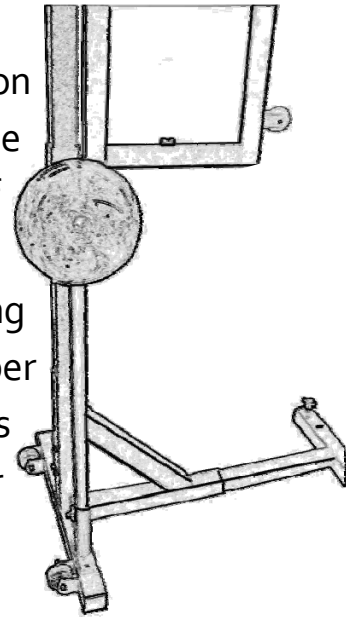

The most important indicator of lower back problems is the lean

- Four separate screenings, with a sampling population between 67 and 214, indicated that:
- 80% of those with a forward lean greater than 3 degrees complained of lower back pain.
- Only 30% of those with a forward lean less than 3 degrees complained of lower back pain.



Measuring Scoliosis

Pneumex has developed a non-invasive technique for measuring and documenting the degree of Scoliotic curves using the MAP. Using this technique with the Measure and Analyze Scoliosis software, we have an effective, easy-to-use, non-invasive, and repeatable method of documenting a patient's degree and Scoliotic curvature and their progress in the program.

In comparing this method with current x-rays we have been able to achieve a high degree of accuracy. **This is not meant to replace X-rays, etc**

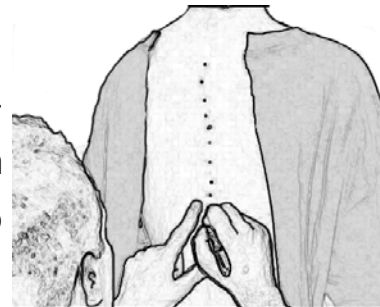

Fig 11

To use this technique:

Make a series of dots on the patient's back, showing the center of the spinous process at each vertebral level. Figure 11

Now center the wheel (previously inked with an erasable pad) on the spinous process at S.L5.



Fig 12

NOTE: Patient is positioned relative to MAP, same as for A.P Tracing.

Bring the wheel up to T1 and trace a plumb line down the center of the patient's back. Figure 12



Fig 13

Now palpate the spine to identify the corresponding vertebral level of each of these points. **Figure 13**

NOTE: If a person is unstable or if a lateral shift is present, a second person will be required to stabilize the patient in an upright position.

tion.

Bring the pen back up and make a horizontal jog on MAP, corresponding to each vertical key point. **Figure 14**

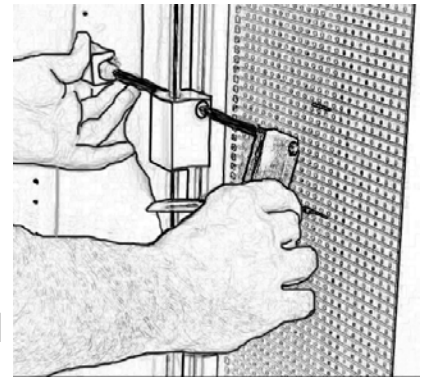

Fig 14

Measure from the center of the apex of the spinous process to the center of back (point B) record this distance in centimeters. **Figure 15**

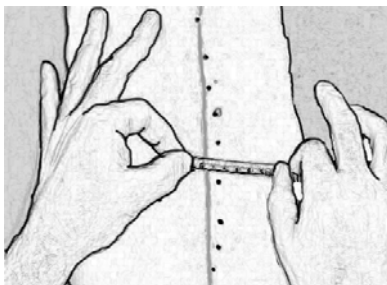

Fig 15

15

*NOTE: a micrometer can be extremely useful in quickly recording accurate

measurements

Repeat this process if an S curve is present.

Our MAP (**Figure 16**) will now have three or five levels identified, and the patient (**Figure 17**) will have three or five levels identified also.

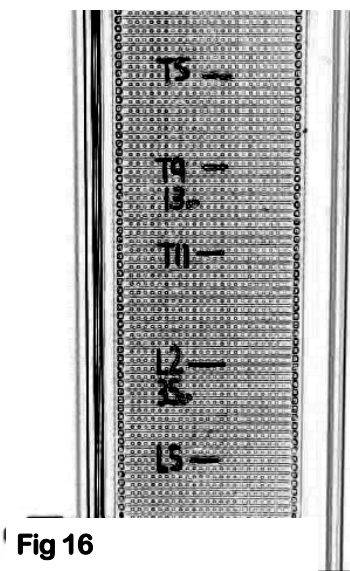

Fig 16

A, B, C for "C" curve

A, B, C, D, E for "S" curve

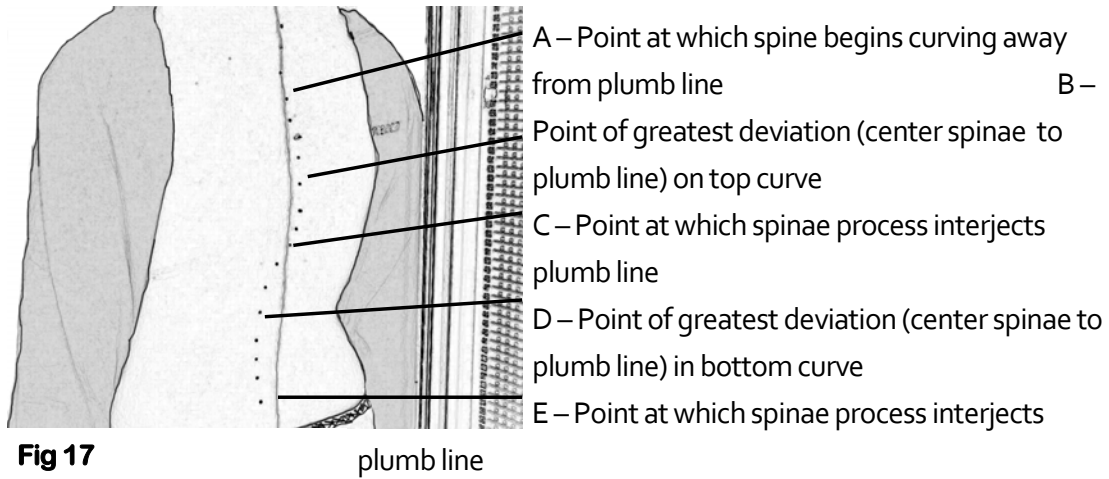

Fig 17

Once the patient has been marked the clinician will identify the vertebral level of each of the dots and corresponding MAP Level

e.g.	Point	Vertebral Level	Map Level
	A	@ T ₃	77
	B	@ T ₇	59
	C	@ T ₁₁	46
	D	@ L ₁	35
	E	@ L ₃	26

Measure from dots B and D to the center of the Spinous process

B – 3.2 cm right convexity

D – 1.2 cm left convexity

Identify whether the convex side of the thoracic curve is to the patients right or left

Right thoracic curve

Left lumbar curve

We now have all the information we need for data entry. The logic the computer will use to come up with the basic program will be:

- To identify the upper curve as the primary curve
- To stabilize the pelvis

Add lumbar distraction 8 to 10 min

Pick a first resistance point on the convex side one vertebral level above our C point.

Do 15 repetitions or to fatigue

- Add a secondary stabilization level below C and pick a resistance point on the convex side at the apex of the curve Point B

Do fifteen repetitions or to fatigue

- Move secondary stabilization level to apex and move resistance to convex side 1 vertebral level below Point A

For detailed information on using the MAP software see the Pneumex Analysis Instruction booklet that came with your software

Map Assembly

Base Unit Assembly

Attach (b) posture simulator holder to (a) main base

- Remove both screws from bottom of (b) holder.
- Insert screws from underside of (a) through larger holes.
- Align (a) and (b) finding screw holes in (b).
- Tighten both screws.

Attach (c) braced upright receptacle to (a) main base

- Remove two screws from (c) braced upright receptacle.
- Insert screws from underside of (a) through larger access holes.
- Align (a) and (c) find screw holes in (c).
- Tighten both screws.

Add T slider unit

- Loosen T slider adjusting screw insert T slider into open end of wheeled base then tighten.

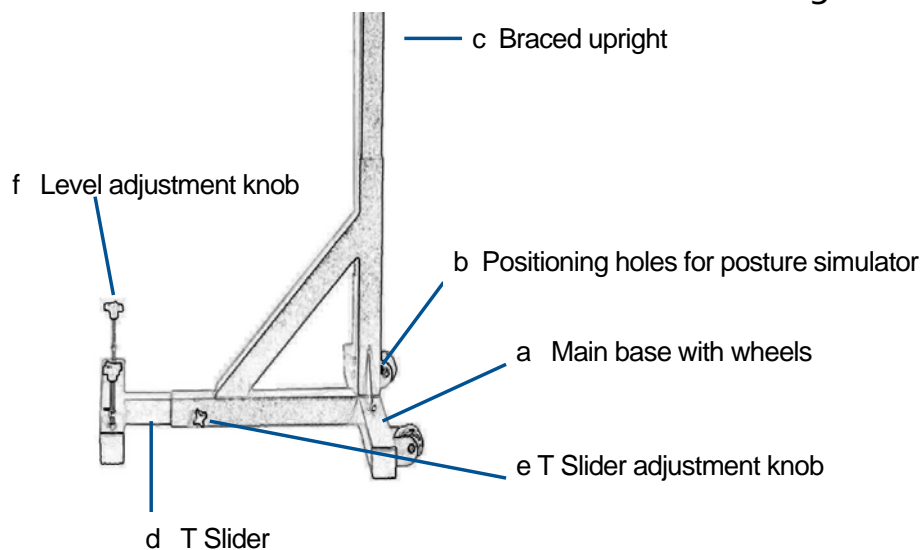

Upright Post & Grid Assembly

Install assembly into base unit

Remove 2 button head bolts from post end with $7/32$ " Allen-head wrench (included).

Insert post assembly with grid into the base until it hits bottom, with the bolt hole toward back of base assembly unit.

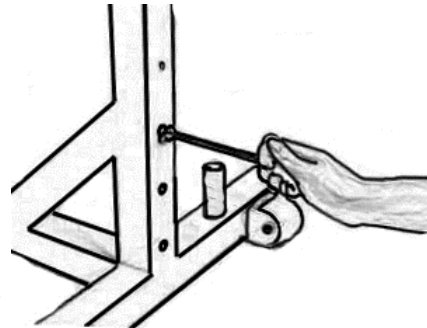

Screw button head bolt through base into post.

*Note-Base unit has various holes for height adjustment of upright post.

Install stylus and pen block

Push the threaded end of the stylus rod through the slider block on the vertical rod of the grid assembly.

Screw the white stylus roller onto the stylus rod.

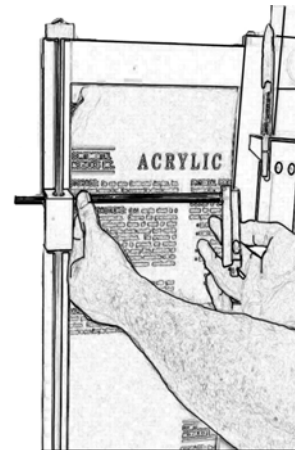

Leveling the MAP

Find the level gauge on bottom side of grid frame. Make adjustments as necessary using the level adjustments knobs in the base unit. Remove the cap from the pen, place the pen in the stylus, pushing in all the way. Tighten the screw and you are ready to begin a screening.

Be sure to use only **Vis-à-Vis** wet erase pens.

Loosen screw height adjustment knob at top of grid assembly. Support grid, while sliding unit to desired height, then tighten knob. Begin by standing patient in front of the MAP with heels up against the base.

Once the patient is lined up make sure the height of the frame is adjusted so that the wheel reaches the sacrum when it is at the bottom of the MAP.

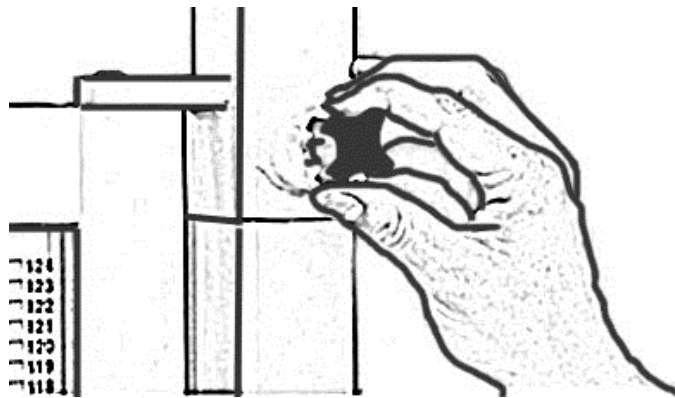

Maintenance

Cleaning

Use a soft cloth rinsed in warm water to clean the exterior surfaces.

Disinfections

Use procedures established for your facility.

Schedule Service

No scheduled service is required. See *Preventive Maintenance* below. For service, call Pneumex:

USA & Canada: 800-447-5792

International: 208-265-4105

Preventive Maintenance

Check and tighten all assembly bolts. Use clean water and cloth to wipe all pen marks clean. Make sure pen is tracking true on grid and is moving up and down freely.

If there are any problems , questions or concerns about the assembly of this equipment please call Pneumex at 800-447-5792

Specifications

PneuMAP	Height	Width	Length	Weight
	83.5"	22.25"	35.5"	75 lb

Troubleshooting

Problem	Possible Cause	Solution
Stylus rod does not travel smoothly		Make sure pen is tracking true on grid and is moving up and down freely.
MAP is too tall/short	Height or level adjustment is incorrect	Re-adjust height and check for level
Unable to remove previous markings	Using wrong pens	Use only vis-à-vis water erase pens
		Clean vis-à-vis with water
		Clean other marker Try coloring over the marking with a black dry erase marker. Then erase the marking, this will remove most of the permanent marking. Use a general solvent based or citrus based cleaner

Your Warranty

If a product purchased from Pneumex does not operate properly, Pneumex will repair or replace it at no charge, for up to one year from the date shipped. In the course of repair or replacement, Pneumex may send you written recommendations on how to prevent a problem from occurring again. Pneumex reserves the right to withdraw this warranty if recommendations are not followed. The customer is responsible for freight charges both to and from Pneumex in all cases.

This warranty does not apply to compressors which are covered by the compressor manufacturers.

This warranty is exclusive and is in lieu of all other warranties whether written, oral or implied, including the warranty of fitness for any particular purpose. Pneumex liability is in all cases limited to the replacement price of its product. Pneumex shall not be liable for any other damages, whether indirect, consequential, or incidental arising from the sale or use of its products.

Pneumex sales personnel may modify this warranty, but only by signing a specific written description of any modifications.

Pneumex
2605 Boyer Ave
Sandpoint, ID 83864
pneumex@pneumex.com
www.pneumex.com
800-447-5792



Pneumex Equipment



treat. restore. thrive.

PneuThera Treatment Protocols