

FRENCH FITNESS

FFM-PLR / FFN-PLR

French Fitness Marin and Napa
P/L Iso-Lateral Rowing Low Row

ASSEMBLY MANUAL



FEATURES

- Paint Color: Silver
- Vinyl Color: Black
- High quality steel tube Q235 with 50 x 80 x 3mm
- Tungsten Inert Gas (TIG) welding
- Quality PU leather
- Electrostatic powder coating

TECH SPECS







- Weight: 282 lb (128 kg)
- Dimensions: 59"L x 50"W x 52"H (1500 mm x 1270 mm x 1300 mm)

WARRANTY



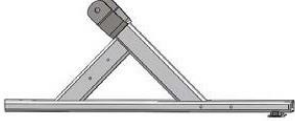
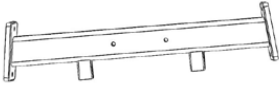
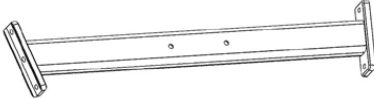
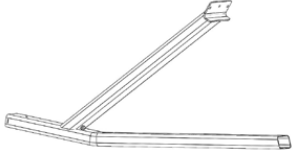
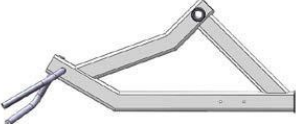
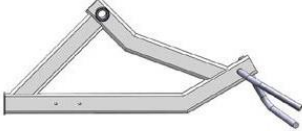

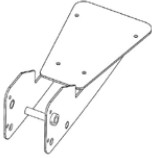
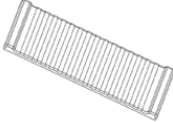
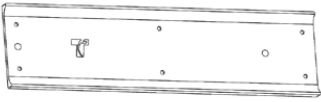





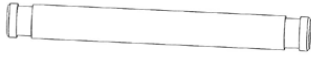

- **10 Years Parts, 1 Year Labor (Commercial)**

PARTS LIST

Individual packaging

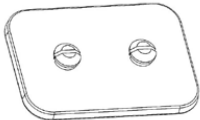
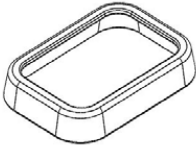
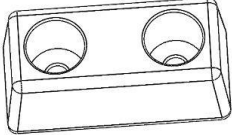
Individual packaging					
					
NO 1	8106-0100*1pc	NO 2	8106-0200*1pc	NO 3	8106-0400*1pc
					
NO 4	8106-0700*1pc	NO 5	8106-0500*1pc	NO 6	8106-0600*1pc
					
NO 7	8106-0300*1pc	NO 8	8106-0800*1pc	NO 9	Right hanging counterweight combination*1pc
					
NO 10	Left hanging counterweight combination*1pc	NO 11	1000*1pc	NO 12	Seat track A*1pc
					
NO 13	Seat track B*1pc	NO 14	Cushion*1pc	NO 15	Chest pad*1pc

PARTS LIST

Assembly part					
					
NO 16	NO.111*2pcs	NO 17	8101-0605*1pc	NO 18	8101-0606*1pc
					
NO 19	GT004*4pcs	NO 20	Stainless steel plug*2pcs	NO 21	Stainless steel foot pedal*2pcs
					
NO 22	Galvanized shaft*2pcs	NO 23	Barbell rod fixed sheet metal*2pcs	NO 24	Aluminum cap*4pcs
					
NO 25	New foot pad*4pcs	NO 26	New foot pad cap*4pcs	NO 27	Hard rubber*2pcs
					
NO 28	Combine short pieces*4pcs	NO 29	0606 pipe plug*5pcs	NO 30	0607 pipe plug*4pcs

PARTS LIST

Assembly part



NO 31

Bearing*4pcs

Blister Pack Screw List-4 (Standard Parts)

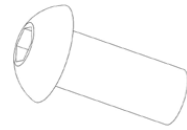
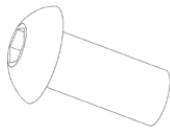
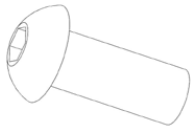

A

Hexagon socket flat head screws M10*125

B

Hexagon socket flat head screws M10*75

C

Hexagon socket flat head screws M10*60

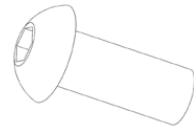
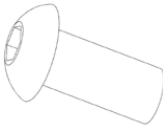
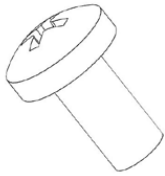

D

Cross recessed head screws M4*8

E

Hexagon socket flat head screws M8*20

F

Hexagon socket flat head screws M8*30

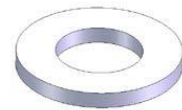
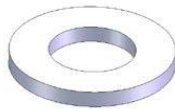

G

Locknut M10

H

Flat gasket M12

I

Flat gasket M10

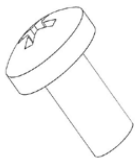

J

Cross recessed round head screws M8*80

K

LocknutM8

MAIN FRAME ASSEMBLY STEPS

Step NO	Item NO	Name	Qty	Item NO	Name	Qty	
1	NO 1	8106-0100	1	NO 5	8106-0500	2	
	NO 2	8106-0200	1		M10 hex socket screw		
	NO 3	8106-0400	1				
	NO 4	8106-0700	8				
Tools		6#Inner hexagon screwdriver, wrench					

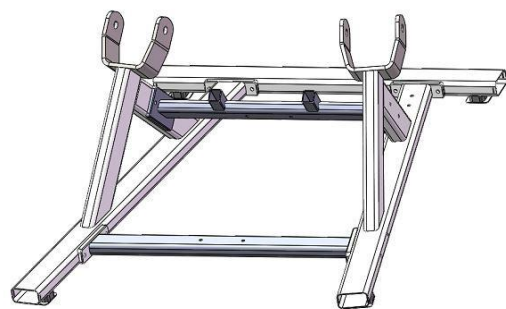
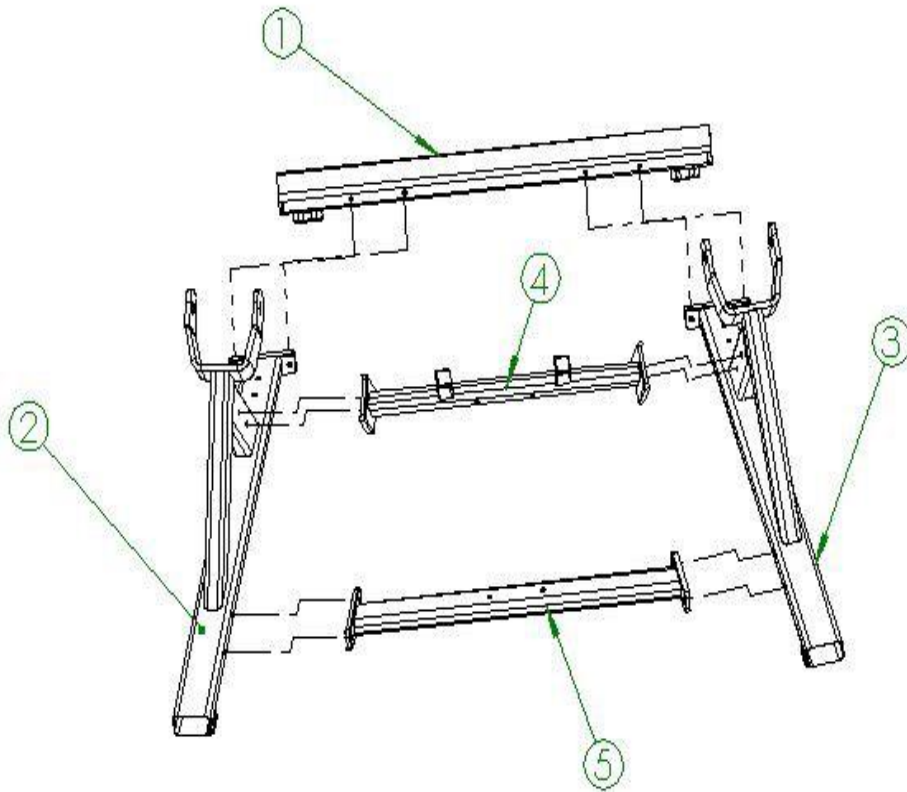

Step NO	Item NO	Name	Qty	Item NO	Name	Qty	
2	NO 6	8106-0600	2				
	NO 7	8106-0300	1				
	NO 8	8106-0800	12				
Tools		6#Inner hexagon screwdriver, wrench					

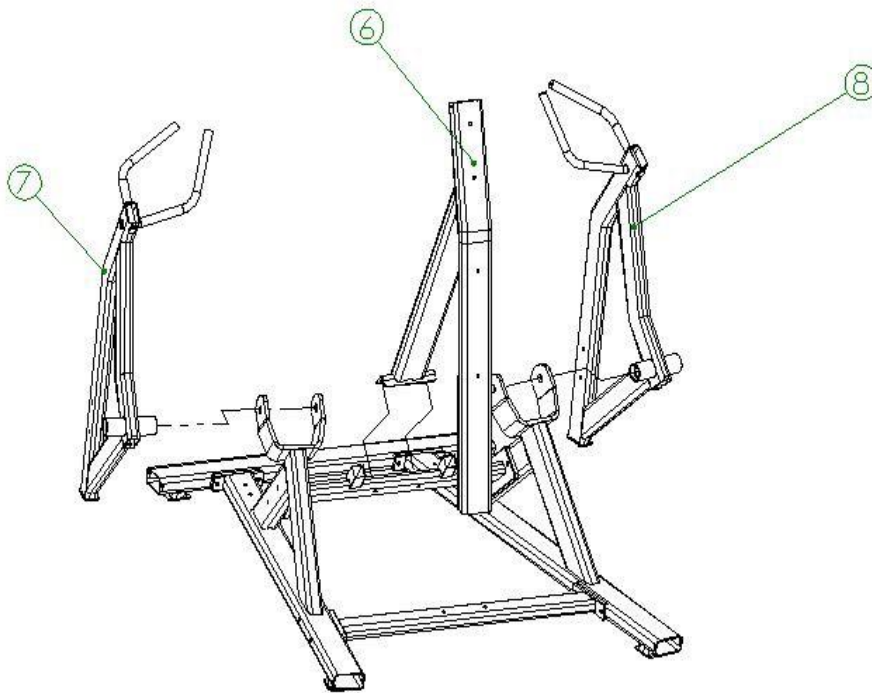

Step NO	Item NO	Name	Qty	Item NO	Name	Qty
3	NO 9	Right hanging counterweight combination	1	13	Seat track B	
	NO 10	Left hanging counterweight combination	1	14	Cushion	
	NO 11	1000	1	15	Chest Pad	
	NO 12	Seat track A	1			
Tools						

