

NuStep[®] T5/T5^{XR}

Recumbent Cross Trainer

USER MANUAL



Transforming Lives[®]

Contents

Introduction	4
Safety Instructions.....	5-6
Installation and Placement	7
AC Adapter Use.....	8
T5 Feature Overview	9
T5 StrideLock®.....	10
1-2-3-Go!	11-12
Correct Riding Position & Swivel Seat Operation	13
Dorsi/Plantar Foot Pedal Operation.....	14
Console Operation.....	15
Programs Overview	16-19
Viewing and Exporting Data	20-21
Data Logging	22
User Tracking	23
Additional Features.....	24
Manager Mode.....	25-26
Preventive Maintenance and Troubleshooting.....	27
Warranty and Serial Number Information.....	28
Obtaining Customer Service and Parts.....	29
Technical Data	30
Replacing Batteries.....	31-32
Safety Notifications.....	33-34
EMC Tables.....	35-38
US FCC Compliance & IEC/EN 55011 Compliance.....	39
Appendix A.....	40

Introduction

Thank you for purchasing the NuStep T5 or T5^{XR} Recumbent Cross Trainer, the latest innovation in cardiovascular fitness equipment from NuStep, LLC.

T5 and T5^{XR} cross trainers are suitable for physical therapy, cardiopulmonary rehabilitation, sports medicine and general fitness purposes.

The T5 and T5^{XR} mark a milestone in NuStep's continuous pursuit of advancement, customer satisfaction, and best-in-class quality. As a customer-focused company, NuStep turned to our customers, including health care professionals, fitness experts, and home users, for insight on what features to include in the product. The T5 and T5^{XR} are the end-result of this valuable feedback.



New and improved core features of the T5 and T5^{XR} model include:

- An advanced ergonomic design.
- A smoother stepping motion.
- A quiet electronic braking system with 15 levels of resistance, and higher accuracy.
- A larger and lower step-through area for easier transfer on and off.
- A larger, more comfortable seat that swivels 360° for transfer on and off from all directions.
- A large color monitor with vivid resolution and multiple language capability.
- A wider variety of workout programs including: Quick Start, Manual, Profiles, and Pace Partner.
- Increased weight capacity: 500 lb. (T5 model) or 600 lb. (T5^{XR} model).
- Oversized and cushioned foot pedals (T5 and T5^{XR} models) and dorsi/plantar flexion operation (T5^{XR} model).

As the originator of the recumbent cross trainer, NuStep is the leader in developing total body exercise systems that are safe, effective, and easy-to-use. Our products are used in healthcare facilities, wellness centers, and senior living residences around the world, and millions of NuStep users have transformed their lives through exercise – even when they were unable to use other exercise equipment.

Thank you for your business and welcome to our ever-expanding network of NuStep users.

Safety Instructions

	 CAUTION	 WARNING
<p>This is the safety alert symbol. It is used to call attention to instructions concerning personal safety. Read and obey all safety messages that follow this symbol to avoid possible injury or death resulting from misuse.</p>	<p>CAUTION indicates a potentially hazardous situation, which if not avoided, may result in minor or moderate injury. It may also be used to alert against unsafe practices.</p>	<p>WARNING indicates a potentially hazardous situation, which, if not avoided, could result in death or serious injury.</p>

 WARNING
<p>Do not modify this equipment without authorization of the manufacturer.</p> <p>Injuries to health may result from incorrect or excessive training.</p> <p>Heart rate monitoring systems may be inaccurate. Over exercising may result in serious injury or death. If you feel faint stop exercising immediately.</p>

Safety Instructions



CAUTION

See your physician before beginning any exercise program.

Supervision is required if you have a disability or medical condition.

Stop exercising if you feel faint or dizzy while using this product, and seek medical help or advice.

Use this product only as directed by your physician if you have any type of heart disease, hypertension, diabetes, respiratory disease, or any other medical problem, or if you are pregnant.

Read this manual before using this product and save it for future reference.

Always wear shoes and proper clothing when exercising.

Do not operate this product if it appears damaged or inoperable. Examine product regularly for damage and wear. Ensure defective components are replaced immediately.

Do not perform maintenance or repairs on this product while it is in use.

Make sure the seat position and upper arm position are correctly setup for you. Do not over-extend your legs or your arm reach.

Do not let children use this



CAUTION

product.

Do not use this product in the presence of children and/or pets.

The heart rate, watts, METs and calories displays are not suitable for use in applications where the health and safety of the patient may be dependent on the accuracy of those parameters.

Prior to using the target heart rate program, consult physician for guidance on proper target heart rate.

Use of the exercise protocol program requires medical supervision and compliance with exercise testing guidelines.

The maximum user weight is 500 lbs (227 kg) for the T5 model and 600 lbs (272 kg) for the T5^{XR} model.

Do not lift this product by yourself. The T5/T5^{XR} is very heavy; it weighs 298 lbs (135 kg).

To avoid injury, or damage to the product, always obtain assistance to move this product. Use proper lifting techniques.

To avoid injury, do not insert hands in any cover openings.

To ensure safe operation of this product, place on a flat stable surface. Adjust leveler feet as required.

Installation and Placement

Unpacking and Installation

Unpacking and installation procedures for T5/T5^{XR} shipments are documented in the applicable T5/T5^{XR} delivery installation guideline documents. The installation guideline documents are shipped with the products. Additional copies of these documents are available upon request from NuStep, LLC. customer service.

Placement of Equipment

To ensure safe and effective operation of your NuStep, place on a flat, stable surface. Adjust rear leveler feet as required.

The minimum amount of required free space around the equipment is 24 inches (61 cm) for the sides, and 12 inches (30 cm) for the front and rear. Additional free space is necessary to accommodate wheelchair access.

CAUTION

The T5/T5^{XR} is very heavy; it weighs 298 lbs (135 kg).

To avoid injury, or damage to the product, always obtain assistance to move this product.

Use proper lifting technique.

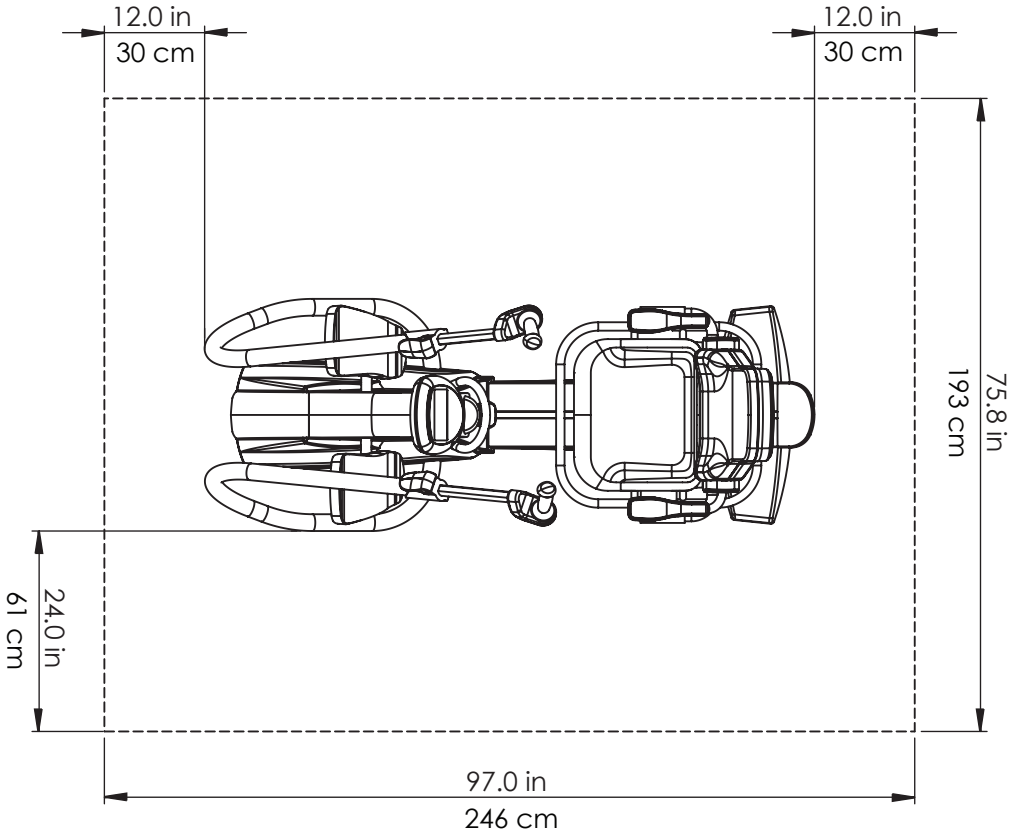

AC Adapter Use

The T5/T5^{XR} is self powered and typically does not require an external power source. However, to ensure proper operation, the equipment must be plugged in with the provided AC adapter for low work rates (approximately 60 steps per minute or less). The AC adapter jack is located in the front of the equipment.

For adapter specifications, please refer to the technical data section of this manual.

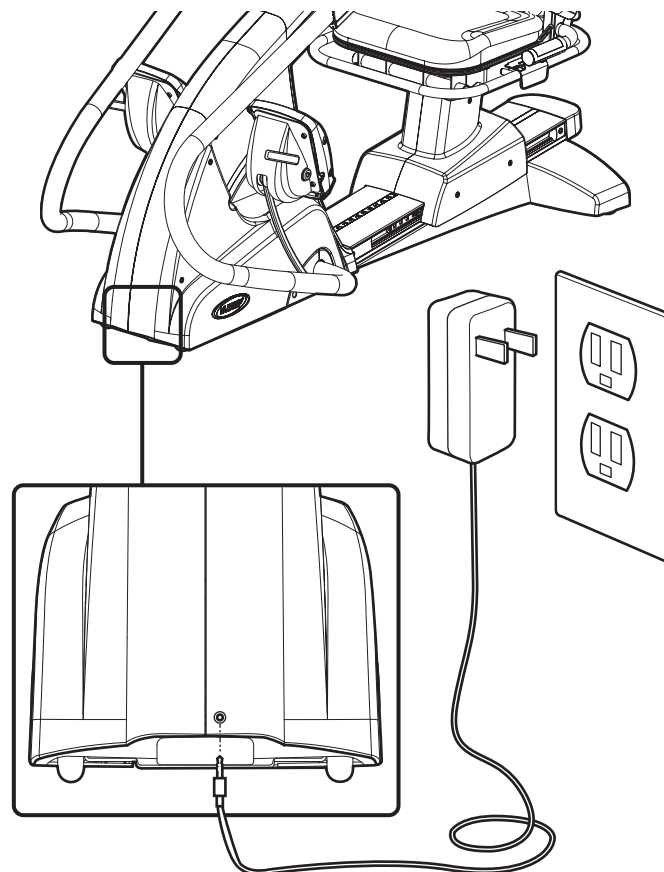

T5 Feature Overview

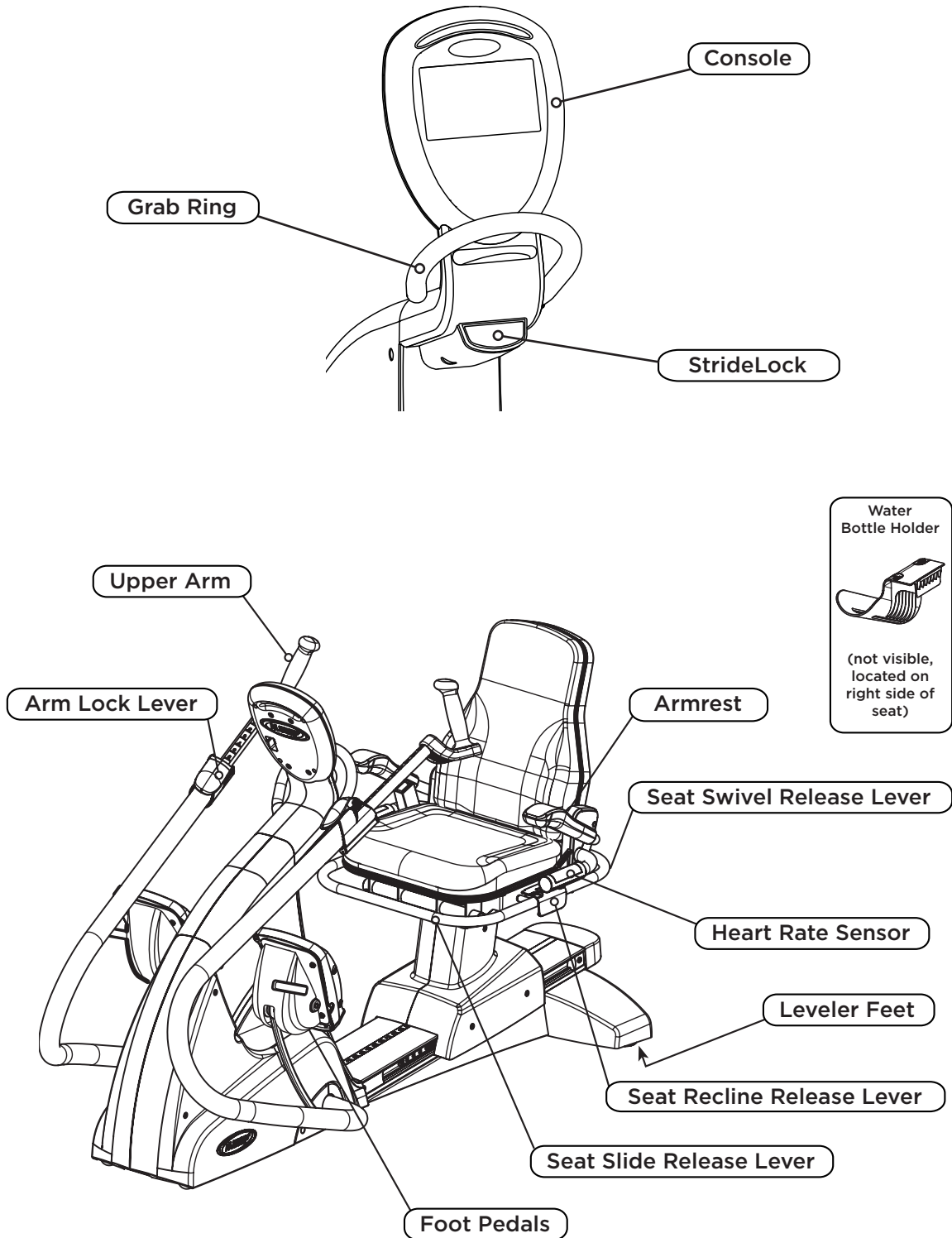

* Features vary based on model, T5^{XR} model shown above.

T5 StrideLock®

The NuStep StrideLock feature allows users to lock the arms and pedals of the T5. Locking the arms and pedals stabilizes the product making it easier for users to get on and off. Locking the arms and pedals also makes it easier to adjust the seat and upper arms. Use of the StrideLock is recommended when putting on optional adaptive accessories such as the foot secure system and leg stabilizer. (For information about optional accessories, please visit our website, nustep.com.) To use the StrideLock, please follow the below instructions.

1. Place the arms and pedals in the desired position by pushing or pulling one of the upper arm grips.



2. To lock the arms and pedals, push the StrideLock button. Verify that the lock is engaged by pushing or pulling the upper arm grip.

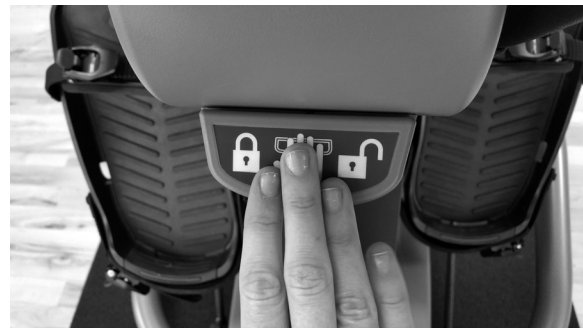

3. To unlock the arms and pedals, push the StrideLock button again.



Note: Do not attempt to lock the StrideLock while the arms and pedals are in motion.

1-2-3-GO

Press the How to Use button on the console to see this information on the console screen.

1. ADJUST SEAT DISTANCE



- Lift the front seat release lever.
- Move seat until knee is slightly bent when leg is almost fully extended.

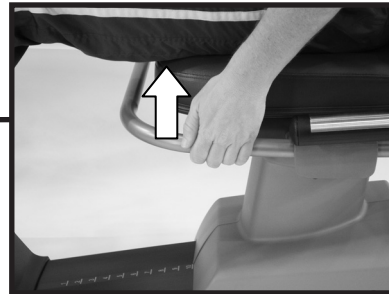

2. ADJUST SEAT BACK ANGLE (T5^{XR} MODEL ONLY)



- Lift the center seat recline lever.
- Adjust seat back until comfortable and release seat recline lever.
- Up to 12° recline possible.



1-2-3-GO

3A. ADJUST HANDLE DISTANCE

- Lift blue release lever on arms to unlock arm handles.
- Adjust handles until elbow is slightly bent when arm is almost fully extended (for many people this may be the same number as their seat position).
- Press blue release lever down to lock into position.

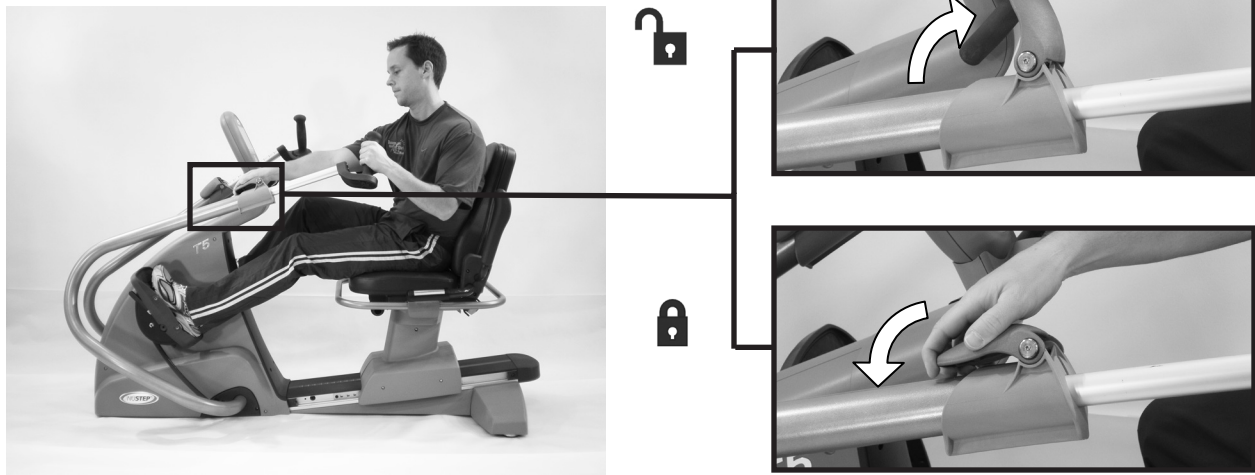

3B. ADJUST ARM ROTATION (T5^{XR} MODEL ONLY)

- Lift the blue release lever to unlock the upper arm and rotate the arm (in or out).
- Each number or click represents a **rotation of 10 degrees**. Once set, push the blue release lever down to lock.

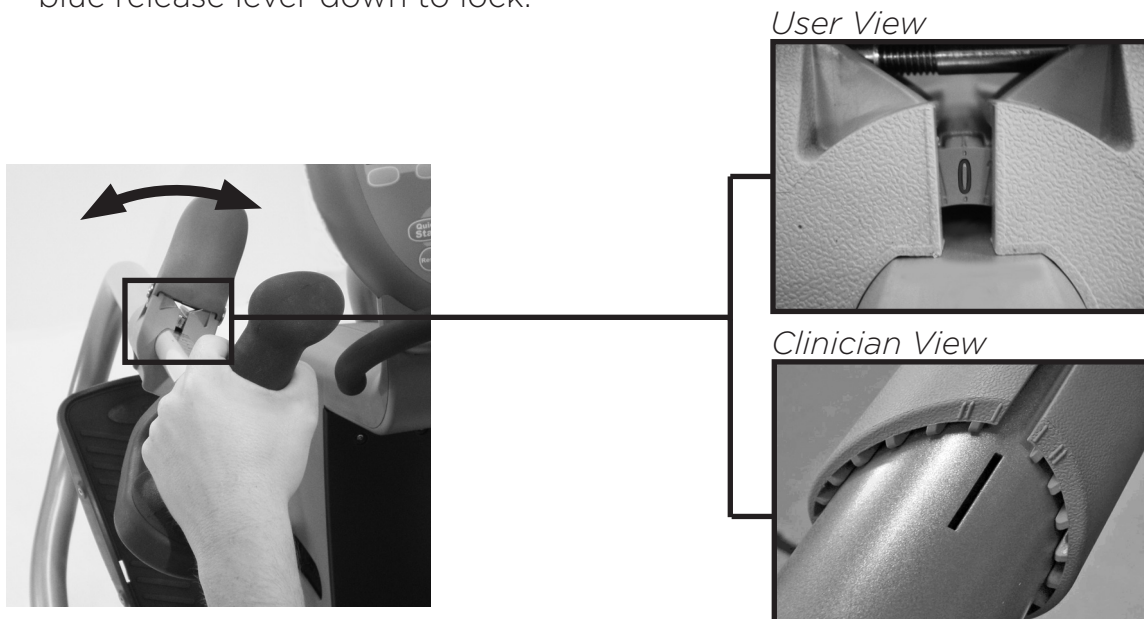

Correct Riding Position on T5

After adjusting your T5, there should be a slight bend in your legs and arms at nearly full extension when exercising with your T5.



CAUTION

Injuries to health may result from incorrect or excessive use.

Ensure the seat and arms are set up in biomechanically correct positions.

Do not over-extend your leg or arm reach distance.



Swivel Seat Operation

- Lift rear swivel release lever.
- Swivel seat in either direction to help get on and off the seat.
- The seat can swivel 360° and lock every 45°.

Note: For safety, the seat cannot be slid forward or backward unless facing forward.



Dorsi/Plantar Foot Pedal Operation (T5^{XR} Only)

- Unlock for dorsi/plantar operation.
- Lock in any three positions to set angle.

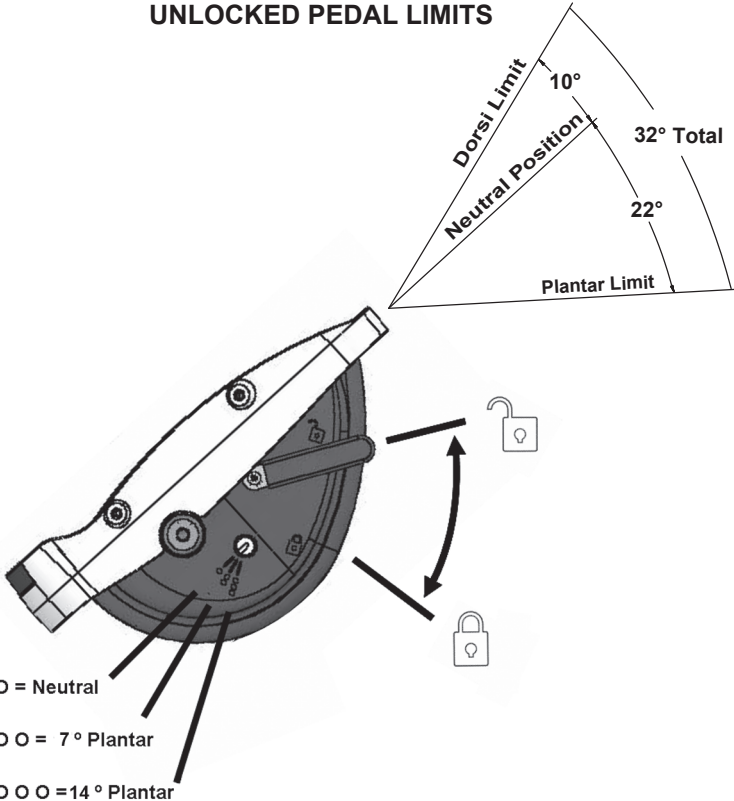

LOCKED PEDAL POSITIONS

Console Operation

The NuStep T5 console is easy to use. An **automatic on/off feature** turns on the console as soon as you move the arm handles or foot pedals and automatically shuts down when you stop exercising for three minutes.

The console goes directly to the **Quick Start** program when you move the arm handles and foot pedals or press any button.

To change the program press the **Change Program** button.



A. Information center:

Displays the user's workout data and set up screens for entering information.

B. Soft key buttons:

Select the various buttons to change the information shown or to change the programs.

C. Up and down arrow buttons:

Use the up and down arrows to adjust values or workload. Press and hold the up or down button for faster scrolling.

D. Quick Start:

Select this button to enter directly into a workout. This will bypass any setup.

E. Reset:

When reset is selected it is a hard reset and completely resets all information.

F. Enter:

Select Enter to input information.

G. Information:

The button is context sensitive and explains the information on the screen.

H. Standby power indicator:

When the T5 and T5^{XR} Recumbent Cross Trainer equipment is plugged in and not in use, the standby power indicator flashes while battery is charging. When charging is complete, the standby power indicator remains on without flashing.

Programs Overview

Quick Start



This program automatically starts just by moving the arm handles or foot pedals. It also bypasses entering goal information. The user can manually change the workload as desired by using the up and down arrow buttons.

Manual



This program is very similar to Quick Start. However, it requires the user to enter their weight and goal information. The user can also enter a goal of time, distance, or calories.

Profiles

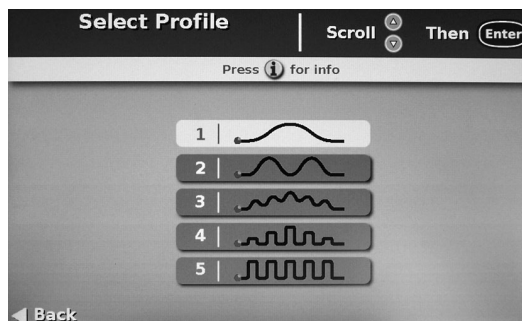

This program provides five profiles for different levels of interval training.

Pace Partner



The pace partner program allows the user to enter a pace partner value based on METS, watts or steps per minute (SPM). The user then “races” against the pace partner.

Programs Overview

Target Heart Rate (THR) (T5^{XR} Only)



This program adjusts exercise workload to keep the user's heart rate within a target heart rate range. The user enters their THR before the workout begins. The target heart rate range is calculated based on the following equation: $[THR = (220 - \text{age}) * X\%]$. The exercise intensity is controlled by the "X%" variable. The "X%" lower limit is .50 and the upper limit is .85. The target heart rate equation and range limits are based on guidelines of the American College of Sports Medicine (ACSM) and the American Heart Association (AHA). The user can adjust the THR parameter at any time during the workout. The warm up phase lasts until the user gets to within ~ 10 beats of their target beats per minute (BPM). Note: A heart rate transmitter belt must be worn when using this program.

Constant Speed (Isokinetic) (T5^{XR} Only)



This program helps users workout at a constant stepping speed. The user enters the desired steps per minute (SPM) before the workout begins. The program adjusts the workload to keep the user's SPM speed at a constant rate. If the user's stepping speed exceeds the SPM parameter, the workload increases. If the user's stepping speed falls below the SPM parameter, the workload decreases. The user may increase or decrease SPM anytime during the workout. Note, at very fast or very slow speeds, the program does its best to keep a user at a constant stepping speed, but there is a limit to its capability, and pop-up messages will notify the user at these extremes.

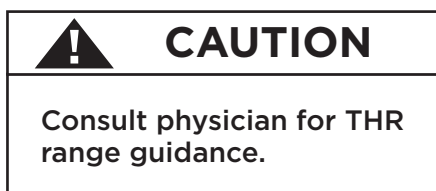

Programs Overview

Constant Power (T5^{XR} Only)



This program allows users to workout at a constant effort. The user enters the desired watts level or METs level before the workout begins. This program adjusts workload in response to the user's stepping speed and step length to keep the watt or MET levels at a constant rate. If the user's stepping speed and force result in watt/MET levels beyond the specified input, workload level decreases. If the user's stepping speed and force result in watt or MET levels below the specified input, workload level increases. The user may adjust the watts/METs parameter at anytime during the workout. Note: there are pop-ups that alert the user if they are going too fast and creating more power than the specified input or if they are going too slow and creating less power than the specified input.

Exercise Protocol (T5^{XR} Only)



These exercise protocol programs are designed to be administered in a clinical setting. If these programs are enabled, the protocols make incremental watt changes every two minutes in a constant power mode for eight stages.

- mTBRS-XT protocol is for sedentary individuals and stroke patients.¹
- TBRS-XT protocol is for y individuals aged 18-45.²

To enable these programs, they have to be turned on in Manager Mode under the Exercise Protocol selection.

⚠ CAUTION

Use of this protocol requires medical supervision and compliance with exercise testing guidelines.

¹ Sandra A. Billinger, Benjamin Y. Tseng, Patricia M. Kluding , "Modified Total-Body Recumbent Stepper Exercise Test for Assessing Peak Oxygen Consumption in People With Chronic Stroke," Physical Therapy 88:10 (October 2008)

² Sandra A. Billinger, Janice K. Loudon, Byron J. Gajewski, "Validity Of A Total Body Recumbent Stepper Exercise Test To Assess Cardiorespiratory Fitness," Journal of Strength and Conditioning Research 22:5 (September 2008)

Programs Overview

Home Mode / Last Workout

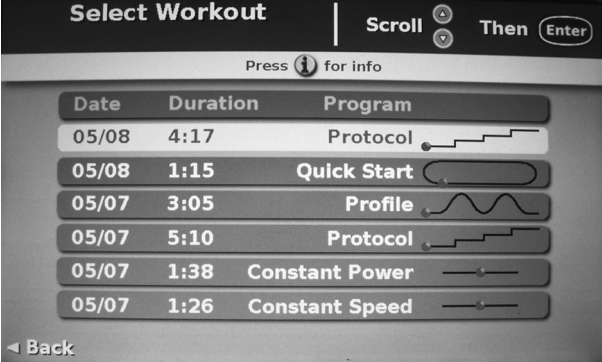

If this feature is enabled, users are able to select “Last Workout” from the Select Program screen by pressing soft key two. This allows users to select any of the last six workouts. For any workout selected, the workout will be identical to what was chosen during that workout. This feature allows a user to conveniently select a previous workout without reentering any data. To enable this feature, it has to be turned on in Manager Mode under the Home Mode selection.

Viewing and Exporting Data

Viewing and Exporting Product and Workout Data

From the Usage Menu in Manager Mode, users may view cumulative product statistics, cumulative user statistics and the last 200 individual user workouts. The Usage Menu can only be accessed from the Manager Mode Menu.

To enter Manager Mode:

- Press the How to Use soft key button.
- Press the down arrow to the Contact and Product heading and press Enter.
- Once in the Contact and Product screen, simultaneously press and hold the second soft key button, the fourth soft key button and Enter (as shown).



Select Usage Menu from the Manager Mode Menu screen.

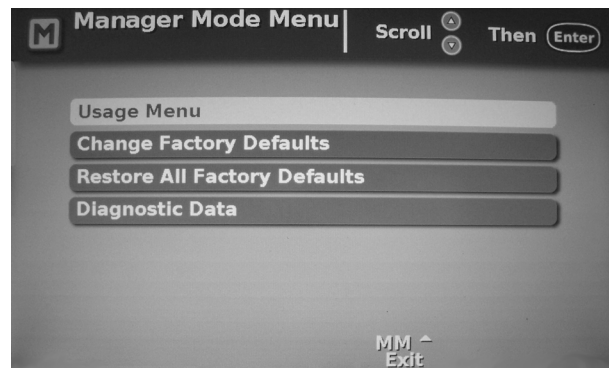

From the Usage Menu, select Cumulative Product Statistics, Cumulative User Statistics or User Tracking to view or export data.



Viewing and Exporting Data

Exporting Data

Cumulative product and use data may be exported from either the Cumulative Product Statistics screen or the Cumulative User Statistics screen. User workout data may be exported from the User Tracking screens.

To export data, insert USB flash drive into back of console, navigate to desired screen and press Write to Flash Drive soft key button.



Cumulative Product Statistics

The cumulative product statistics screen provides an overview of product use including software versions and the amount of product use. This screen can also be accessed from any workout screen by simultaneously pressing and holding the first soft key button and Enter.

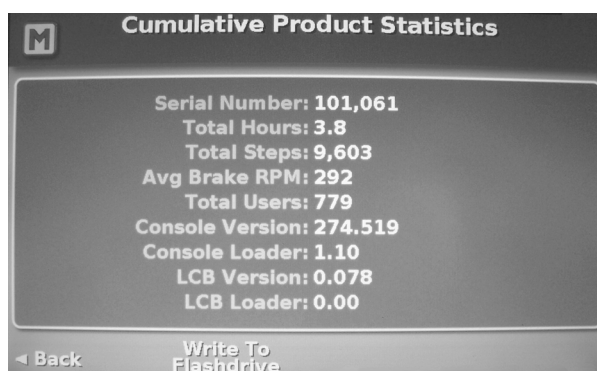

Cumulative Product Statistics	
Serial Number:	101,061
Total Hours:	3.8
Total Steps:	9,603
Avg Brake RPM:	292
Total Users:	779
Console Version:	274.519
Console Loader:	1.10
LCB Version:	0.078
LCB Loader:	0.00

◀ Back Write To Flashdrive

Cumulative User Statistics

The cumulative user statistics screen provides an overview of how the equipment is being used by all users.

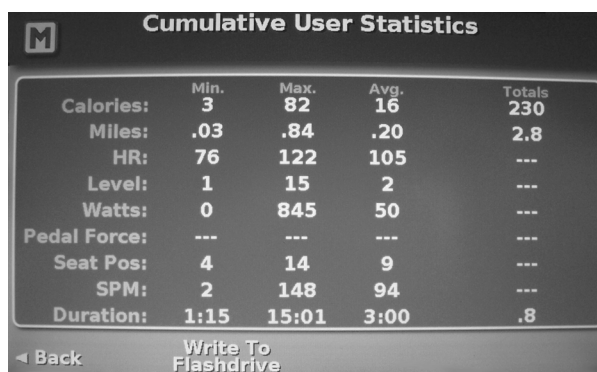

Cumulative User Statistics				
	Min.	Max.	Avg.	Totals
Calories:	3	82	16	230
Miles:	.03	.84	.20	2.8
HR:	76	122	105	---
Level:	1	15	2	---
Watts:	0	845	50	---
Pedal Force:	---	---	---	---
Seat Pos:	4	14	9	---
SPM:	2	148	94	---
Duration:	1:15	15:01	3:00	.8

◀ Back Write To Flashdrive

Data Logging

Data Logging

The Data Logging feature provides an additional data export option for users of the T5/T5^{XR}. When the feature is enabled in Manager Mode and a flash drive is installed on the back of the console, incremental workout data will be saved to the flash drive every 20 seconds. At any point in time, a user can remove the flash drive and upload the data to a PC. The data is saved on the flash drive as a comma delimited text file with the name user.txt.



Enabling Data Logging

To enable Data Logging, the feature must be turned on in Manager Mode.

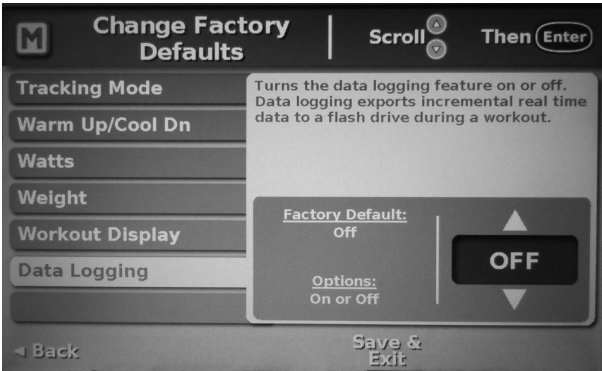

User Tracking

User Tracking

The user tracking screen allows users to view or export workout data for the last 200 individual workouts. Note, this feature always tracks the last 200 workouts and is FIFO (first in first out) data. If you wish to track a PIN with a workout, you must turn on User Tracking in Manager Mode.



To view or export individual workout records, scroll through the workout records and select the desired record. The workout records provide a complete summary of the workout.

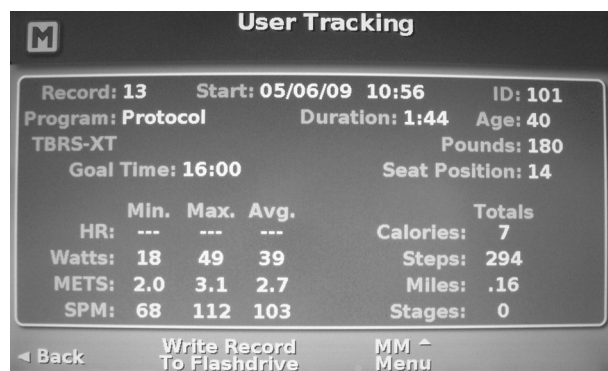

Enabling User Tracking

To make tracking of user data more specific and show outcomes, it is advisable to turn on User Tracking in Manager Mode. This enables users to enter a personal identification number (PIN) of up to six digits before every workout. Their workout data is then tracked by this PIN. Users who do not wish to use a PIN when User Tracking is enabled may simply press the Enter button twice to bypass this input screen before a workout.

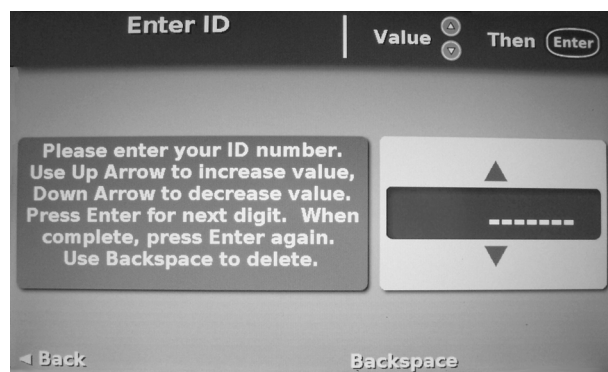

Additional Features

On-the-fly programming

This feature allows a user the ability to change programs anytime during a workout. Note, a workout must be 60 seconds in length and .03 miles (.05 km) if you wish to transfer the workout data to another program; otherwise, it starts from zero. Note: This feature is not available for the exercise protocol programs.

Battery saver mode

To save the battery during inactivity, the product will go into battery saver mode after two weeks to preserve the battery. To remove it from this state, simply step very quickly. Although this feature is automatic, it may also be manually placed into this state when the unit is off by pressing and holding any button for 10 seconds.

Average button

When the average button is pressed, the cumulative workout averages are displayed on the console screen for 6 seconds. The console will automatically return to the workout screen or you may press the continue workout soft key button to return to the workout screen sooner.

Load 0 (zero)

Load 0 gives an even lower workload level than Load 1. Load 0 only displays and works when the unit is plugged into a power outlet and provides the absolute lowest workload setting available.

Flash Device Programming Capability

To upgrade to the latest software version, download the latest version to a flash device and insert into back of console while T5 unit is off. Turn unit on and the reprogramming process will begin automatically. Do not remove the flash device until prompts tell you reprogramming is complete.

How to Use

Access all information from the How to Use button available during any workout. This button allows a user to find out how to use the product. Note, context sensitive i button is also available.

Manager Mode

Manager Mode allows authorized personnel to change factory default settings (see listing of default settings on the following page).

To enter the Manager Mode:

- Press the How to Use soft key button.
- Press down arrow to the Contact and Product heading and press Enter.

Once in the Contact and Product screen:

- Simultaneously press and hold the 2nd and 4th soft key buttons then press Enter (as shown).



Usage Menu

View cumulative statistics, firmware version, and user workout data.

Change Factory Defaults

Allows you to customize settings to your needs.

Restore All Factory Defaults

Globally restores all factory defaults.

Diagnostic Data

Calls up diagnostic screen.

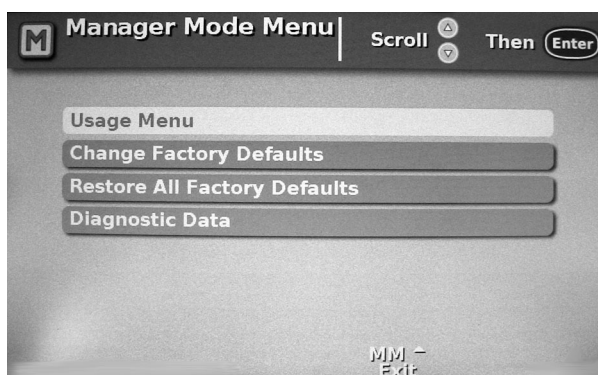

To change a default setting:

- Select Change Factory Defaults.
- Scroll up or down to access that setting, e.g. Age.
- Press Enter and the selected default will highlight in red.
- Use the up or down arrows to select the new default setting (the console shows both the factory default and the range for each setting).
- Press Enter to set the new default.
- Use scroll to access other settings.
- Press Save & Exit anytime to save your settings and exit manager mode.

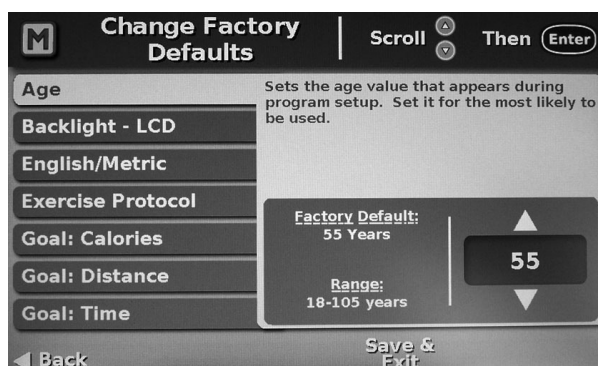

Manager Mode

SETTINGS	DEFAULT	RANGE/OPTIONS
Backlight - LCD	7	1 - 10 backlight values, 10 being the highest.
English/Metric Units	English	Select English or metric data units.
Exercise Protocol	Off	Turn exercise protocol program on or off.
Goal: Calories	188	5 - 3500 calories. Set the most likely value that appears during program setup. This also sets the maximum calorie limit.
Goal: Distance	2.25	0.1 - 10 miles (.16 - 16 km). Set the most likely value that appears during program setup. This also sets the maximum distance limit.
Goal: Time	40	1 - 99 minutes. Set the most likely value that appears during program setup. This also sets the maximum time limit.
Home Mode	Off	Turn home mode feature on or off.
Language	English	Chinese, Danish, Dutch, English, French, German, Italian, Japanese and Spanish
METS	2.6	1.0 - 27.0 METS
Sound	General: Low Events: Low THR Alarms: Med Every Step: Off	Sets the general volume, volume for significant events, THR range alarms, and can turn on an every step sound.
Steps Per Minute	100	25 - 200 steps per minute
THR	.70	.55 - .90 Sets the percent used to calculate the target heart rate that appears during program set up or when wearing a chest strap. Based on ACSM guidelines.
Time - function Time Zone	Elapsed Eastern Time	Time elapsed or remaining for workout as primary choice. Time and date may be adjusted for any time zone.
Tracking Mode	Off	Turn user tracking mode on or off.
Warm up / cool down	12.5%	5 - 12.5% of workout time. Sets percentage length of warm-up and cool-down phases based on total goal entered, per ACSM guidelines. The default is 12.5% warm-up, 75% work out, and 12.5% cool-down.
Watts	60	25 - 400 watts
Weight	180 lbs	75 - 500 lbs for T5 model or 75 - 600 lbs for T5 ^{XR} model.
Workout display	Calories, Distance	Select from calories or METS, distance or steps.

Preventive Maintenance

Preventive Maintenance Intervals

Although your T5 is designed to be maintenance free, a few tasks are recommended to increase the useful life of the NuStep. Please follow the recommended preventive maintenance intervals according to the amount of usage that the NuStep receives. These are estimated intervals and you may need to increase or decrease the time period between preventive maintenance depending on your actual use. Refer to appendix A for additional information about preventive maintenance and repairs in clinical settings.

ITEM	TASK	FREQUENCY
Console	* Clean	Weekly
Covers and Frame	* Clean	Weekly
Seat	* Clean	Weekly
* Use a non-abrasive spray cleaner and a soft cloth to clean the NuStep.		

Troubleshooting

MALFUNCTION	POTENTIAL CAUSE	CORRECTIVE ACTION
No heart rate when wearing chest strap	Chest strap electrodes are not wet enough.	Wet the belt.
	User is not wearing a coded chest strap transmitter.	Contact NuStep to order a coded chest strap transmitter.
	Chest strap transmitter battery has expired.	Contact Polar USA, www.polarusa.com .
	Chest strap transmitter electrodes are not directly in contact with skin.	Review instructions for proper location of chest strap transmitter.
No heart rate when holding contact grips	Acquiring contact heart rate requires 12-15 seconds.	Hold both grips until a heart rate appears.
	Varying contact heart rate grip tension or position.	Keep a steady even grip on contact heart rate handles.
	User is only grasping sensors with one hand.	Grasp both sensors.
	Hands are too wet.	Dry hands off.

T5 Warranty

To view or print your T5 warranty online, go to: www.nustep.com

If you have any questions about your warranty, please contact customer service, 800-322-4434 or support@nustep.com.

Customers outside the United States and Canada may obtain warranty information from the local distributor in the country where the product was sold.

T5 Serial Number Information

Location on the product:

The T5 serial number is located on the lower back (see image below) and on the console display screen.

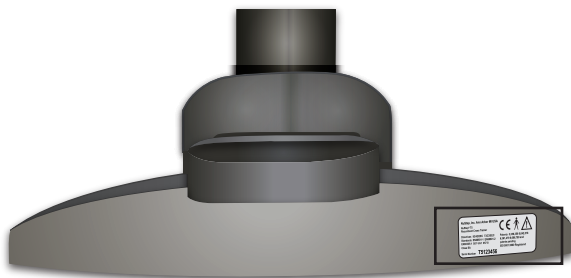

Displaying on the console screen:

Press the How to Use button, arrow down to Contact and Product, then press the Enter button.

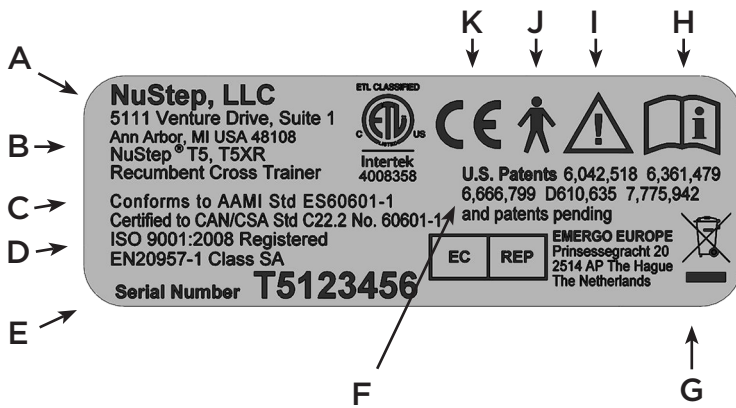

A	Manufacturer's name and address
B	Model number and description of product
C	Compliance with directives and standards
D	Quality management system registered to ISO standard
E	Serial number and date of manufacture
F	Patent protection for the product
G	WEEE Directive Mark
H	Consult the user manual before use
I	Attention read accompanying documents
J	Type B applied part for electrical safety
K	CE Mark

Obtaining Customer Service and Parts

STEP 1

Identify the problem.

Speak with the person who reported the problem to get a good understanding of the problem.

STEP 2

Verify the problem.

Inspect the cross trainer, and determine what parts may be required to correct the problem. Figures and parts lists may be obtained from the NuStep, LLC. website or by contacting customer service.

STEP 3

Record the serial number, total hours, total steps, firmware version, and LCB version for the NuStep recumbent cross trainer.

The total steps, total hours of use, firmware version and LCB version values may be viewed on the cumulative statistics screen of the console. To access the screen:

1. Press the Quick Start button.
2. Press the Enter button and the first soft key button simultaneously.

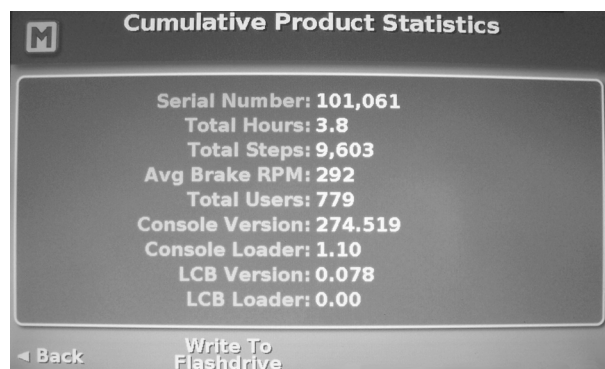

STEP 4

Contact NuStep, LLC. customer service.

Please have the serial number and a complete description of the problem so our product specialists can better assist you.

Product specialists can be reached via e-mail, phone or fax at:

E-mail: support@nustep.com

Phone: 800-322-4434 or
734-769-4400

Address: NuStep, LLC.
5111 Venture Drive
Suite 1
Ann Arbor, MI 48108
USA

Web: www.nustep.com

Customers outside the US and Canada, may obtain customer service by contacting their local NuStep distributor.

Technical Data

Maximum User Weight	T5 Model = 500 lbs (227 kg) T5 ^{XR} Model = 600 lbs (272 kg)
User Height Range	4'6"– 6'7" (137.16 cm – 200.66 cm)
Weight of Equipment	T5 Model = 285 lbs (129 kg) T5 ^{XR} Model = 295 lbs (134 kg)
Dimensions: (length/height/width)	73" (185 cm) 46" (117 cm) 30" (76 cm)
Sealed lead-acid cell battery	12 volt 7.0 Amp. Hour (PowerSonic PS-1270F1) (NuStep, LLC. part number 50216)
Lithium Ion Coin Cell Battery	3v (Panasonic CR-2032)
Alkaline Battery	AA batteries, quantity 2, (Energizer EN91) (NuStep, LLC. part number 41224). Note: If NuStep will not be used for several months, remove AA batteries.
USB Port	The T5/T5 ^{XR} console includes a USB host port for data transfer. Note: USB port is for flash drive use only.
Standards	ANSI/AAMI ES60601-1, CAN/CSA-C22.2 No. 60601-1, IEC/EN 60601-1, IEC/EN 60601-1-2, IEC/EN 60335-1, EN 20957-1, EN 957-8 Class SA
Directives	93/42/EEC 2014/35/EU 2014/30/EU 2014/53/EU 2011/65/EU
Generator resistance	Range 0 - 1400 watts
Braking system, stepping action and watts testing parameters	For braking system, stepping action and watts testing parameters, refer to appendix A.
Marks	
AC Adapter (optional)	Model (Ault/SL Power MENB1020A1572B02, ME20A1503B01 or ME20A1572B02) Output 15V dc @ 1.2 A Medical SMPS Input 100-240V~ 50-60Hz, 400 mA

Replacing 12 Volt Lead Acid Battery

Tools Required

- 3 mm hex bit
- 8 mm deep socket

1. Remove AC adapter from outlet if plugged in.
2. Remove 4 screws from front end trim cover and remove cover from frame.



3. Remove 2 screws from right upper cover and remove cover from frame.

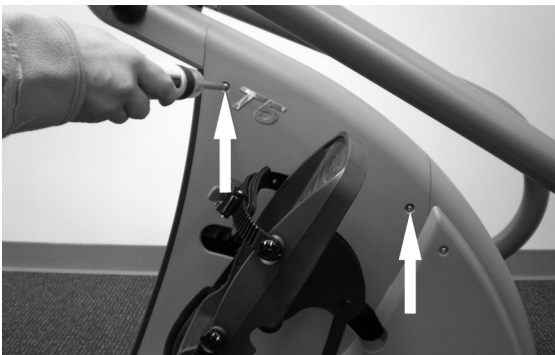

Ratchet and extension

4. Remove two locknuts.

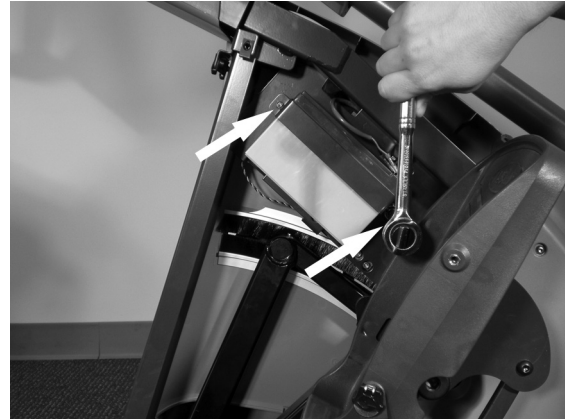

5. Remove the battery cables.



6. Remove battery.

7. Follow steps in reverse order to install new battery. (Note: Be sure that the red cable goes to the positive (red) side of the battery and the black cable goes to the negative (black) side of the battery.)



CAUTION

Do not dispose of batteries in a fire. The batteries may explode.

Do not open or mutilate batteries. They contain an electrolyte which is toxic and harmful to the skin and eyes.

To avoid personal injury due to energy hazard, remove wrist watches and jewelry such as rings when replacing the batteries.

Replace batteries with the same number and type of batteries as originally installed in the equipment.

Recycle batteries in accordance with local recycling procedures.

Replacing Contact Heart Rate AA Batteries

Tools Required

None

1. Remove cover under the front of the seat bottom.



2. The AA batteries that power the contact heart rate transmitter are located under the seat. Remove batteries and install two new AA alkaline batteries.



CAUTION



Do not dispose of batteries in a fire. The batteries may explode.

Do not open or mutilate batteries. They contain an electrolyte which is toxic and harmful to the skin and eyes.



Replace batteries with the same number and type of batteries as originally installed in the equipment.

Recycle batteries in accordance with local recycling procedures.

Safety Notifications

TYPE / DEGREE OF PROTECTION	CLASSIFICATION / IDENTIFICATION / WARNINGS	SYMBOL
Type of protection against electric shock	Class II equipment	
The degree of protection against electric shock	Type B applied part	
The degree of protection against the ingress of liquids	Not protected	NA
The degree of safety in the presence of a flammable anesthetic mixture with air or with oxygen or nitrous oxide	Not suitable	NA
The mode of operation	Continuous	NA
Information regarding potential electromagnetic or other interference and advice regarding avoidance	The NuStep® T5 and the T5 ^{XR} Recumbent Cross Trainers use electromagnetic and RF energy only for its internal function. Therefore, its EMC and RF emissions are very low and are not likely to cause any interference in nearby electronic equipment.	NA
EMC warnings and tables required by IEC 60601 -1 -2	See EMC tables.	NA
ID of specified optional external power supplies or battery chargers necessary to ensure compliance with the requirements of IEC 60601	An external power supply is optional due to a sealed lead-acid cell battery operation, but if required, the power supply specified in the technical data section of this manual must be used.	NA

Safety Notifications

TYPE / DEGREE OF PROTECTION	CLASSIFICATION / IDENTIFICATION / WARNINGS	SYMBOL
<p>ID of any risks associated with the disposal of waste products, residues, including disposal of the equipment itself at the end of its useful life.</p>	<p>The NuStep® T5 and T5^{XR} Recumbent Cross Trainer equipment contains electronic circuit assemblies, a sealed lithium coin cell battery and a sealed lead acid cell battery that may require compliance with specific local disposal or recycling procedures.</p>	
<p>The specification of the environmental conditions of transport and storage (also marked on the outside of the packaging).</p>	<p>The NuStep® T5 and T5^{XR} Recumbent Cross Trainer equipment can be:</p> <p>a) safely transported and stored in these conditions -10° to 50°C; ≤ 95% non-condensing humidity; 20 to 107 kPa.</p> <p>b) operated in these conditions 5° to 40°C; ≤ 85% non-condensing humidity; 60 to 107 kPa.</p>	<p>NA</p>
<p>A description of the means for the isolation of the equipment from the supply.</p>	<p>The NuStep® T5 and T5^{XR} Recumbent Cross Trainer equipment can be isolated by unplugging the power supply from the wall and run on batteries alone. The power supply has an isolation transformer and fuseable link.</p>	<p>NA</p>
<p>Indication that the equipment is energized.</p>	<p>When the T5 and T5^{XR} Recumbent Cross Trainer equipment is plugged in and not in use, the standby power indicator flashes while battery is charging. When charging is complete, the standby power indicator remains on without flashing.</p>	

EMC Tables

Guidance and manufacturer's declaration - electromagnetic immunity

The NuStep® T5 and T5^{XR} Recumbent Cross Trainer equipment is intended for use in the electromagnetic environment specified below. The customer or user of the NuStep® T5 or T5^{XR} Recumbent Cross Trainer should make sure that it is used in such an environment.

Immunity test	IEC 60601 test level	Compliance level	Electromagnetic environment - guidance
<p>Conducted RF IEC 61000-4-6</p> <p>Radiated RF IEC 61000-4-3</p>	<p>3 Vrms 150 kHz to 80 MHz</p> <p>3 V / m 80 MHz to 2,5 GHz</p>	<p>3 Vrms</p> <p>3 V / m</p>	<p>Portable and mobile RF communications equipment should be used no closer to any part of the NuStep® T5 Recumbent Cross Trainer, including cables, than the recommended separation distance calculated from the equation applicable to the frequency of the transmitter.</p> <p>Recommended separation distance</p> <p>$d = 1,2 \sqrt{P}$</p> <p>$d = 1,2 \sqrt{P}$ 80 MHz to 800 MHz</p> <p>$d = 2,3 \sqrt{P}$ 800 MHz to 2.5 GHz</p> <p>Where P is the maximum output power rating of the transmitter in watts (W) according to the transmitter manufacturer and d is the recommend separation distance in metres (m).</p> <p>Field strengths from fixed RF transmitters, as determined by an electromagnetic site survey, ^A should be less than the compliance level in each frequency range . ^B</p> <p>Interference may occur in the vicinity of equipment marked with the following symbol:</p> 

NOTE 1 At 80 MHz and 800 MHz, the higher frequency range applies.

NOTE 2 These guidelines may not apply in all situations. Electromagnetic propagation is affected by absorption and reflection from structures, obstructions and people.

^A Field strengths from fixed transmitters, such as base stations for radio (cellular/cordless) telephones and land mobile radios, amateur radio, AM and FM radio broadcast and TV broadcast cannot be predicted theoretically with accuracy. To assess the electromagnetic environment due to fixed RF transmitters, and electromagnetic site survey should be considered. If the measured field strength in the location in which the NuStep® T5 Recumbent Cross Trainer is used exceeds the applicable RF compliance level above, the NuStep® T5 Recumbent Cross Trainer should be observed to verify normal operation. If abnormal operation performance is observed, additional measures may be necessary, such as reorienting or relocating the NuStep® T5 Recumbent Cross Trainer.

^B Over the frequency range 150 kHz to 80 MHz, field strengths should be less than $[V_1]$ V/m.

EMC Tables

Guidance and manufacturer's declaration - electromagnetic emission

The NuStep® T5 and T5^{XR} Recumbent Cross Trainer equipment is intended for use in the electromagnetic environment specified below. The customer or the user of the NuStep® T5 or T5^{XR} Recumbent Cross Trainer should make sure that it is used in such an environment.

Emissions Test	Compliance	Electromagnetic environment - guidance
RF emissions CISPR 11	Group 1	The NuStep® T5 Recumbent Cross Trainer uses RF energy only for its internal function. Therefore, its RF emissions are very low and are not likely to cause any interference in nearby electronic equipment.
RF emissions CISPR 11 Harmonic emissions IEC 61000-3-2 Voltage fluctuations / flicker emissions IEC 61000-3-3	Class B Not applicable. Rated power is ≤ 75 W. Not applicable. Rated power is ≤ 75 W. Equipment is unlikely to produce significant voltage fluctuations.	The NuStep® T5 Recumbent Cross Trainer is suitable for use in all establishments.

EMC Tables

Guidance and manufacturer's declaration – electromagnetic immunity

The NuStep® T5 Recumbent Cross Trainer is intended for use in the electromagnetic environment specified below. The Customer or the user of the NuStep® T5 Recumbent Cross Trainer should assure that it is used in such an environment.

Immunity test	IEC 60601 Test level	Compliance level	Electromagnetic environment - guidance
Electrostatic discharge (ESD) IEC 61000-4-2	± 6 kV contact ± 8 kV air	± 6 kV contact ± 8 kV air	Floors should be wood, concrete or ceramic tile. If floors are covered with synthetic material, the relative humidity should be at least 30%.
Electrical fast transient/burst IEC 61000-4-4	± 2kV for power supply lines	± 2kV for power supply lines	Mains power quality should be that of a typical commercial or hospital environment.
Surge IEC 61000-4-5	± 1 kV differential mode ± 1 kV common mode	± 1 kV differential mode ± 2 kV common mode	Mains power quality should be that of a typical commercial or hospital environment.
Voltage dips, short interruptions and voltage variations on power supply input line IEC 61000-4-11	<5% U_T (>95% dip in U_T) for 0,5 cycles 40% U_T (60% dip in U_T) for 5 cycles 70% U_T (30% dip in U_T) for 25 cycles <5% U_T (>95% dip U_T) for 5 sec	<5% U_T (>95% dip in U_T) for 0,5 cycles 40% U_T (60% dip in U_T) for 5 cycles 70% U_T (30% dip in U_T) for 25 cycles <5% U_T (>95% dip U_T) for 5 sec	Mains power quality should be that of a typical commercial or hospital environment. If the user of the NuStep® T5 Recumbent Cross Trainer requires continued operation during power mains interruptions, the NuStep® T5 Recumbent Cross Trainer would be powered from its internal batteries.
Power frequency (50/60 Hz) Magnetic field IEC 61000-4-8	3 A/m	3 A/m	Power frequency magnetic fields should be at levels characteristic of a typical location in a typical commercial or hospital environment.

NOTE U_T is the a.c. mains voltage prior to application of the test level.

EMC Tables

Recommended separation distance between portable and mobile RF communications equipment and the NuStep® T5 Recumbent Cross Trainer

The NuStep® Recumbent Cross Trainer is intended for use in an electromagnetic environment in which radiated RF disturbances are controlled. The customer or the user of the NuStep® T5 Recumbent Cross Trainer can help prevent electromagnetic interference by maintaining a minimum distance between portable and mobile RF communications equipment (transmitters) and the NuStep® as recommended below, according to the maximum output power of the communications equipment.

Rated maximum output power of transmitter W	Separation distance according to frequency of transmitter		
	150 kHz to 80 MHz	80 MHz to 800 MHz	800 MHz to 2.5 GHz
	d = 1,2	d = 1,2	D = 2,3
0,01	0,12	0,12	0,23
0,1	0,38	0,38	0,73
1	1,2	1,2	2,3
10	3,8	3,8	7,3
100	12	12	23

For transmitters rated at a maximum output power not listed above, the recommended separation distance d in metres (m) can be estimated using the equation applicable to the frequency of the transmitter, where P is the maximum output power rating of the transmitter in watts (W) according to the transmitter manufacturer.

NOTE 1 At 80 MHz and 800 MHz, the separation distance for the higher frequency range applies.

NOTE 2 These guidelines may not apply in all situations. Electromagnetic propagation is affected by absorption and reflection from structures, objects and people.

US FCC Compliance & IEC/EN 55011 Compliance

US FCC Compliance Statement:

Note: This equipment has been tested and found to comply with the limits for a Class B Digital Device, pursuant to Part 15 of the FCC Rules. These limits are designed to provide reasonable protection against harmful interference in a residential installation. This equipment generates, uses and can generate radio frequency energy and, if not installed and used in accordance with the installation instructions, may cause harmful interference to radio communications. However, there is no guarantee that interference may not occur in a particular installation. If the equipment causes harmful interference to radio or television reception, which can be determined by turning this equipment off and on, the user is encouraged to try and correct the interference by one or more of the following measures:

- Reorient or relocate the receiving antenna.
- Increase the separation between the equipment and the receiver.

Connect the equipment into an outlet on a circuit which is different from that to which the receiver is connected.

Consult the dealer or an experienced radio/TV technician for help.

IEC/EN 55011 Compliance Statement:

This device complies with IEC/EN 55011, Group 1, Class B. Group 1 contains all ISM equipment in which there is intentionally generated and/or used conductively coupled radio-frequency energy which is necessary for the internal functioning of the equipment itself. Class B equipment is suitable for use in domestic establishments and in establishments directly connected to the low voltage power supply network which supplies buildings used for domestic purposes.

Trademarks:

The Bluetooth® word mark and logos are registered trademarks owned by the Bluetooth SIG, Inc. and any use of such marks by NuStep,LLC is under license. Other trademarks and trade names are those of their respective owners.

Appendix A

Braking system:

The T5/T5^{XR} models feature both speed dependent and speed independent braking resistance depending on program type. Target heart rate, constant speed, constant power and exercise protocol programs are speed dependent. All other programs are speed independent programs. For program descriptions, refer to the program overview section of this manual.

Stepping action:

The T5/T5^{XR} models feature dependent stepping action with 2" - 8.5" (5 - 21.5 cm) stepping range.

Displayed watts testing parameters:

Displayed watt values represent the energy consumption rate of the user. They are calculated in real-time utilizing an algorithm based on mechanical parameters of the machine and a measured average ride style. The significant mechanical parameters that influence the displayed watt values include the inertia of the machine's moving components, the load level selected by the user, and the rotational velocity of the hybrid brake generator. Validation testing of the displayed watt values was performed by comparing said value and the actual measured mechanical power produced through an average eight inch step by multiple users of varying age, weight, and gender. Comparison of the displayed and measured values took place at seven step rates between 40 and 160 steps per minute at each of the 15 load levels. Displayed watt values are independent of any physiological or anatomical parameter possessed by the user.

Clinical Settings Note

In clinical settings, patients may operate this equipment in accordance with this user manual and the instructions and guidance provided by the health-care personnel responsible for supervising their treatment and care. However, patients shall not perform preventive maintenance, repairs or replace batteries on equipment installed in clinical facilities.

European Authorized Representative



EMERGO EUROPE
Prinsessegracht 20
2514 AP The Hague
The Netherlands

NuStep, LLC.
5111 Venture Drive, Suite 1
Ann Arbor, MI 48108
U.S.A.
(800) 322-4434
(734) 769-4400
www.nustep.com



The information in this manual is the most current at the time of printing. Due to our commitment toward continuous improvement, specifications and descriptions are subject to change without notice. No part of this manual may be reproduced or transmitted in any form or by any means, electronic or mechanical, for any purpose without the express written permission of NuStep, LLC. © Copyright September 2017 by NuStep, LLC.

NuStep® and Transforming Lives® are registered trademarks of NuStep, LLC.

Patents 6,042,518, 6,361,479, 6,666,799, D610,635, 7,775,942 and patents pending

ISO 9001:2008 Registered

Manual PN 50274 T5 User Manual, Rev J

