

95X Cross-Trainer - Engage Console

OPERATION MANUAL



LifeFitness

CORPORATE HEADQUARTERS
5100 North River Road
Schiller Park, Illinois 60176 • U.S.A.
847.288.3300 • FAX: 847.288.3703
800.735.3867 (Toll-free within U.S.A., Canada)

INTERNATIONAL OFFICES

AMERICA'S

**North America
Life Fitness Inc.**

5100 N River Road
Schiller Park, IL 60176 U.S.A
Telephone: (847) 288 3300
Fax: (847) 288 3703
Service Email: internationalservicesupport@lifefitness.com
Sales/Marketing Email: commercialsales@lifefitness.com
Operating Hours: 7:00 am-6:00 pm (CST)

**Brazil
Life Fitness Do Brazil**

Av. Dr. Dib Sauaia Neto 1478
Alphaville, Barueri, SP
06465-140
BRAZIL
Telephone: (800) 773 8282
Fax: (+55) 11.4133.2893
Service Email: suporte@lifefitness.com.br
Sales/Marketing Email: lifefitness@lifefitness.com.br
Operating Hours: 8:30 am-17:30 pm (BRT)

**Latin America & Caribbean*
Life Fitness Inc.**

5100 N River Road
Schiller Park, IL 60176 U.S.A
Telephone: (847) 288 3300
Fax: (847) 288 3703
Service Email: internationalservicesupport@lifefitness.com
Sales/Marketing Email: commercialsales@lifefitness.com
Operating Hours: 8:00am-5:00pm (CST)

**EUROPE, MIDDLE EAST, & AFRICA
(EMEA)**

**Netherlands & Luxemburg
Life Fitness Atlantic BV**

Bijdorplein 25-31
2992 LB Barendrecht
THE NETHERLANDS
Telephone: (+31) 180 646 666
Fax: (+31) 180 646 699
Service Email: internationalservicesupport@lifefitness.com
Sales/Marketing Email: marketing.benelux@lifefitness.com
Operating Hours: 9.00h-17.00h (CET)

**United Kingdom & Ireland
Life Fitness UK LTD**

Queen Adelaide
Ely, Cambs, CB7 4UB
Telephone: General Office (+44) 1353.666017 Customer
Support (+44) 1353.665507
Fax: (+44) 1353.666018
Service Email: uk.support@lifefitness.com
Sales/Marketing Email: life@lifefitness.com
Operating Hours:
General Office: 9.00am - 5.00pm (GMT)
Customer Support: 8.30am - 5.00pm (GMT)

**Germany & Switzerland
Life Fitness Europe GMBH**

Siemensstrasse 3
85716 Unterschleissheim
GERMANY
Telephone: (+49) 89.31 77 51.0 (Germany)
(+41) 0848 000 901 (Switzerland)
Fax: (+49) 89.31 77 51.99 (Germany)
(+41) 043 818 07 20 (Switzerland)
Service Email: kundendienst@lifefitness.com
Sales/Marketing Email: kundenberatung@lifefitness.com
Operating Hours: 9.00h-17.00h (MEZ)

**Austria
Life Fitness Austria**

Vertriebs G.m.b.H.
Dückerstrasse 7-9/3/36
1220 Vienna
AUSTRIA
Telephone: (+43) 1.61.57.198
Fax: (+43) 1.61.57.198.20
Service Email: kundendienst@lifefitness.com
Marketing/Sales Email: kundenberatung@lifefitness.com
Operating Hours: 9.00h-17.00h (MEZ)

**Spain
Life Fitness IBERIA**

C/Frederic Mompou 5,1ªª
08960 Sant Just Desvern Barcelona
SPAIN
Telephone: (+34) 936 724 660
Fax: (+34) 936 724 670
Service Email: info.iberia@lifefitness.com
Sales/Marketing Email: info.iberia@lifefitness.com
Operating Hours:
9.00h-18.00h (Monday-Thursday)
8.30h-15.00h (Friday)

**Italy
Life Fitness ITALIA S.R.L.**

Via Crivellini 7/N
37010 Affi Verona
ITALY
Telephone: (+39) 045.7237811
Fax: (+39) 045.7238197
Service Email: assistenza@lifefitness.com
Sales/Marketing Email: info@lifefitnessitalia.com
Operating Hours: 8.30h -18.00h (CET)

**Belgium
Life Fitness Benelux NV**

Parc Industriel de Petit-Rechain
4800 Verviers
BELGIUM
Telephone: (+32) 87 300 942
Fax: (+32) 87 300 943
Service Email: internationalservicesupport@lifefitness.com
Sales/Marketing Email: marketing.benelux@lifefitness.com
Operating Hours: 9.00h -17.00h (CET)

**All Other EMEA countries &
distributor business C-EMEA***

Bijdorplein 25-31
2992 LB Barendrecht
THE NETHERLANDS
Telephone: (+31) 180 646 666
Fax: (+31) 180 646 699
Service Email: service.db.cemea@lifefitness.com
Sales/Marketing Email:
marketing.db.cemea@lifefitness.com
Operating Hours: 9.00h-17.00h(CET)

ASIA PACIFIC (AP)

**Japan
Life Fitness Japan**

Nippon Brunswick Bldg., #8F
5-27-7 Sendagaya
Shibuya-Ku, Tokyo
Japan 151-0051
Telephone: (+81) 3.3359.4309
Fax: (+81) 3.3359.4307
Service Email:
service@lifefitnessjapan.com
Sales/Marketing Email
sales@lifefitnessjapan.com
Operating Hours: 9.00h-17.00h (JAPAN)

**China and Hong Kong
Life Fitness Asia Pacific LTD**

Room 2610, Miramar Tower
132 Nathan Road
Tsimshatsui, Kowloon
HONG KONG
Telephone: (+852) 2891.6677
Fax: (+852) 2575.6001
Service Email: HongKongEnquiry@lifefitness.com
Sales/Marketing Email: ChinaEnquiry@lifefitness.com
Operating Hours: 9.00h-18.00h

**All Other Asia Pacific countries &
distributor business Asia Pacific***

Room 2610, Miramar Tower
132 Nathan Road
Tsimshatsui, Kowloon
HONG KONG
Telephone: (+852) 2891.6677
Fax: (+852) 2575.6001
Service Email: HongKongEnquiry@lifefitness.com
Sales/Marketing Email: ChinaEnquiry@lifefitness.com
Operating Hours: 9.00h-18.00h

* Also check www.lifefitness.com for local representation or distributor/dealer.

M051-00K70-A035
12/07

Before using this product, it is essential to read this ENTIRE operation manual and ALL installation instructions.

It describes equipment setup and instructs members on how to use it correctly and safely.

Avant d'utiliser ce produit, il est indispensable de lire ce manuel d'utilisation dans son INTÉGRALITÉ, ainsi que TOUTES les instructions d'installations.

Ce manuel explique comment installer l'équipement et comment l'utiliser correctement et sans danger.

FCC Warning - Possible Radio / Television Interference

NOTE: This equipment has been tested and found to comply with the limits for a Class A digital device, pursuant to part 15 of the FCC rules. These limits are designed to provide reasonable protection against harmful interference when the equipment is operated in a commercial environment. This equipment generates, uses and can radiate radio frequency energy, and if not installed and used in accordance with the instruction manual, may cause harmful interference to radio communications. Operation of this equipment in a residential area is likely to cause harmful interference in which case the user will be required to correct the interference at his own expense.

Class SB (Studio): Professional and / or commercial use.



CAUTION: Any changes or modifications to this equipment could void the product warranty.

Mise en garde : tout changement ou toute modification de ce matériel peut annuler la garantie du produit.

Any service, other than cleaning or user maintenance, must be performed by an authorized service representative. There are no user serviceable parts.

TABLE OF CONTENTS

Section	Description	Page
1.	Getting Started5
1.1	Important Safety Instructions5
2.	The Engage Display Console7
2.1	Engage Display Console Overview7
2.2	Engage Display Console Description8
2.3	Reading Rack and Accessory Tray15
3.	Heart Rate Zone Training [®] Exercise16
3.1	Why Heart Rate Zone Training Exercise?16
3.2	Heart Rate Monitoring17
	The Lifepulse™ Digital Heart Rate Monitoring System // The Optional Heart Rate Chest Strap	
4.	The Workouts19
4.1	Workout Overviews19
4.2	Using the Workouts21
	Beginning a Workout // Selecting a Workout // Entering Workout Goals // Entering Workout Values // Using Marathon Mode // Changing/Ending Workouts	
4.3	Workout Hierarchy24
	Workout Descriptions25
	Quick Start // Classic: Manual, Random, Cross-Train Aerobics, Cross-Train Reverse, Hill // Heart Rate +: Fat Burn, Cardio, Heart Rate Hill™, Heart Rate Interval™, Extreme Heart Rate™ // Hill +: Around the World, Cascades, Foothills, Kilimanjaro // Advanced Workouts: Fit Test // Create Your Own (Level Interval and Heart Rate Interval) // Custom (Level Interval and Heart Rate Training)	
	Workout Landscape™ Perspectives32
4.4	Maximizing Workouts on a Life Fitness Cross-Trainer33
	Selecting a Level // Cool Down	
4.5	Additional Features33
	Audio Cues // iPod [®] Compatibility // Virtual Trainer // USB Connectivity // Zoom Feature // Media Center	
5.	System Options Menu34
5.1	Using the System Options Menu34
5.2	Configuration Menu35
	Manager's Configuration 1	
	Language // Units // Workout Duration Configuration // Standby Configuration	
	Manager's Configuration 2	
	Custom Message // Create Your Own // Program Timeout // Fit Test // Marathon Mode // System Beeps // Pause Time // Telemetry // Virtual Trainer // Network // Audio Cues Manager Configuration	
	TV / FM Radio	
	TV Setup // TV Channel Favorites // TV Channel Name/Sort // Promo Channel Setup // Advanced Promo Channel Settings // FM Radio Setup	
	Touch Screen Configuration	
	Export / Import Settings	
5.3	Configuration Settings39
5.4	95 Xe Specifications40
5.5	Warranty Information41

This Operation Manual describes the functions of the following products:

95 Xe Engage Cross-Trainer Console

See "Specifications" in this manual for product specific features.

Health-related injuries may result from incorrect or excessive use of exercise equipment. Life Fitness STRONGLY recommends seeing a physician for a complete medical exam before undertaking an exercise program, particularly if the user has a family history of high blood pressure or heart disease, or is over the age of 45, or smokes, has high cholesterol, is obese, or has not exercised regularly in the past year.



If, at any time while exercising, the user experiences faintness, dizziness, pain, or shortness of breath, he or she must stop immediately.

Des problèmes de santé peuvent être causés par une utilisation incorrecte ou excessive de l'équipement. Life Fitness recommande FORTEMENT de consulter un médecin pour subir un examen médical complet avant de commencer tout programme d'exercice, et tout particulièrement si l'utilisateur a des antécédents familiaux d'hypertension ou de troubles cardiaques, s'il a plus de 45 ans, s'il fume, s'il a du cholestérol, s'il est obèse ou n'a pas fait d'exercice régulièrement depuis un an.



Si, pendant l'utilisation de l'appareil, l'utilisateur ressent un malaise, des vertiges, des douleurs ou des difficultés à respirer, il doit s'arrêter immédiatement.

1 GETTING STARTED

1.1 IMPORTANT SAFETY INSTRUCTIONS

Read all instructions before using the Cross-Trainer.

- If this Life Fitness product does not function properly after it has been dropped, damaged, or even partially immersed in water, contact Life Fitness Customer Support Services for assistance.
- Always follow the console instructions for proper operation.
- Close supervision is necessary when used by children, invalids or disabled persons.
- Do not use this product outdoors, near swimming pools or in areas of high humidity.
- Never operate Life Fitness exercise equipment with the air openings blocked. Keep air openings free of lint, hair or any obstructing material.
- Never insert objects into any opening in this product. If an object should drop inside, carefully retrieve it. If the item cannot be reached, contact Life Fitness Customer Support Services.
- Never place liquids of any type directly on the unit, except in the accessory tray water bottle holder. Containers with lids are recommended.
- Wear shoes with rubber or high-traction soles. Do not use shoes with heels, leather soles, cleats or spikes. Make sure no stones are embedded in the soles.
- Keep all loose clothing, shoelaces and towels away from moving parts.
- Do not use this product in bare feet.
- Do not tip the unit on its side during operation.
- Ensure that there is at least one foot of clearance in front of Life Fitness cross-trainers.
- Use caution when mounting or dismounting Life Fitness exercise equipment. Use the stationary handlebar whenever additional stability is required. While exercising, hold onto the moving arms.
- Never face backward while using Life Fitness exercise equipment.
- Do not stand or sit on pedal lever covers or motor housings.

**SAVE THESE INSTRUCTIONS
FOR FUTURE REFERENCE.**

1 DÉMARRAGE

1.1 CONSIGNES DE SÉCURITÉ IMPORTANTES

Lire toutes les instructions avant d'utiliser le tapis roulant.

FONCTIONNEMENT

- Les instructions de la console doivent toujours être suivies pour obtenir un fonctionnement correct.
- Ne jamais rien insérer dans les ouvertures de cet appareil. Si un objet tombe à l'intérieur de l'appareil, couper l'alimentation électrique, débrancher le cordon de la prise et le récupérer avec précaution. S'il est impossible de l'atteindre, communiquer avec le service à la clientèle de Life Fitness.
- Ne jamais placer aucun liquide directement sur l'appareil, sauf dans le plateau pour accessoires ou un support prévu à cet effet. Il est recommandé d'utiliser des conteneurs munis de couvercles.
- Ne pas utiliser cet appareil pieds nus. Toujours porter des chaussures. Porter des chaussures avec des semelles en caoutchouc ou fournissant une très bonne adhérence. Ne pas utiliser de chaussures à talons, à semelles en cuir ou munies de crampons. S'assurer qu'aucun caillou n'est incrusté dans les semelles.
- Éloigner les vêtements lâches, les lacets et les serviettes des pièces en mouvement.
- Ne pas placer les mains sous l'appareil ou dans l'appareil, et ne pas le renverser sur le côté pendant le fonctionnement.
- Les rampes latérales peuvent servir à rétablir son équilibre, mais ne sont pas destinées à un usage continu.
- Ne jamais monter sur le tapis de course et ne pas en descendre jamais pendant qu'il tourne. Utiliser les rampes latérales afin de ne pas perdre l'équilibre. En cas d'urgence, par exemple, en cas de trébuchement ou de faux pas, saisir les barres latérales et placer les pieds sur les plates-formes latérales.
- Ne jamais marcher ni courir à reculons sur le tapis roulant.
- S'il est nécessaire d'immobiliser le tapis roulant, régler l'afficheur sur SELECT WORKOUT (SÉLECTIONNER EXERCICE). (Appuyer deux fois sur la touche REMISE À ZÉRO si l'afficheur n'en est pas déjà à ce point.) Maintenir ensuite la touche SPEED DOWN (RALENTISSEMENT) enfoncée et appuyer sur la touche PAUSE. L'appareil affiche désormais IMMOBILIZED (Immobilisé). Il ne peut alors plus fonctionner, Le moteur principal, le moteur en ligne et le cireur sont désactivés. Le tapis roulant restera immobilisé, même s'il est réinitialisé, mis hors tension, puis remis sous tension, etc. Le mode de fonctionnement normal ne peut être rétabli qu'au moyen de la même séquence de touches : maintenir la touche SPEED DOWN (RALENTISSEMENT) enfoncée et appuyer sur PAUSE. L'appareil affichera SELECT WORKOUT (SÉLECTIONNER EXERCICE) à nouveau.

**CONSERVER CES INSTRUCTIONS POUR LE
CONSULTER À L'AVENIR.**

2 THE ENGAGE DISPLAY CONSOLE

2.1 ENGAGE DISPLAY CONSOLE OVERVIEW

The Engage LCD console on the cross-trainer allows the user to tailor a workout to personal fitness abilities and goals and to monitor progress. With this easy-to-use console, the user can track fitness improvement from one workout to the next.



a. Touchscreen Display: The Touchscreen Display (the LCD screen) allows the user to choose, set up, and monitor a workout.

b. Options Panel: The Options Panel allows the user to plug in headphones, iPod®, or USB stick.

2.2 ENGAGE DISPLAY CONSOLE DESCRIPTION

This section lists and describes the functions of the buttons on the Touchscreen Display for the Engage LCD console on the 95X Cross-Trainer. See Section 4, *The Workouts*, for detailed information on using the console to set up workouts.

1) TOUCHSCREEN DISPLAY

The Touchscreen Display allows the user to move from screen to screen by simply touching buttons to access other screens. Among many features, the Touchscreen Display enables users to access:

- 1) **SELECT WORKOUT**— choose a workout.
- 2) **VIRTUAL TRAINER SETUP** — choose a Virtual Trainer for workout motivation.
- 3) **USB PRESET SELECTION** — select a saved preset from a USB stick.
- 4) **WORKOUT SETUP** — enter workout values and goals.
- 5) **WORKOUT PROGRESS** — monitor progress, edit workout goals, and access TV viewing.
- 6) **WORKOUT SUMMARY INFORMATION** — view and save workout summary information.
- 7) **MEDIA CENTER** — setup media options.
- 8) **LANGUAGE SELECT** — choose from available languages.
- 9) **VIVO** — fitness networking access.

2) HOME SCREEN

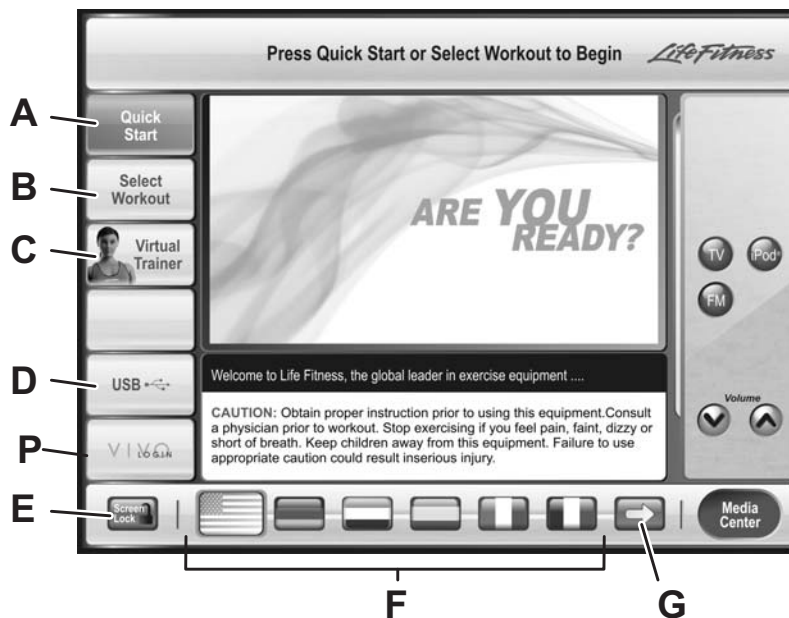

- A. **QUICK START:** Press this button to begin a manual workout immediately, bypassing any setup or goal setting. Once started, the user can then make adjustments to the workout. Once the workout is in progress choose **LEVEL** to determine the resistance level, and **ENTER WEIGHT** so that **Calories Burned/Calories per Hour** and **METS** can be computed and displayed. Select the **COOL DOWN** button on the bottom of the screen to enter a cool down phase when ready.
- B. **SELECT WORKOUT:** Allows the user to choose from a variety of different programs.
See Section 4.1, *Workout Overviews* for a description of each workout.
- C. **VIRTUAL TRAINER:** Allows the user to select a male or female trainer to assist during workout setup and provide audible feedback during a workout.
- D. **USB:** Allows the user to access previously saved workout setup data bypassing the workout setup procedure and immediately entering a workout.

- E. SCREEN LOCK/UNLOCK: (Cannot be used during a workout.) Freezes the screen for the purpose of routine maintenance/screen cleaning. The screen automatically unlocks after ten seconds. Pressing SCREEN LOCK a second time will unlock it as well.
- F. LANGUAGE SELECTION: Allows users to change the language of the interface to one of thirteen possible languages. Select the appropriate language flag from the bottom of the screen.
- G. MORE LANGUAGES: Select this button to see additional language flags.
- P. VIVO: Allows users to access a club's fitness networking system if available.

3) WORKOUT SETUP

Workouts are accessed through the WORKOUT SELECTION button. Workouts are located under one of four workout categories: CLASSIC, HILL +, HEART RATE and ADVANCED. Workouts are listed to the right of each category label. Advancing through the categories will show individual workout descriptions.

WORKOUT SETUP screens are accessed upon selection of a workout program button. They allow the user to enter values or to choose a goal for the workout selected. These depend on the workout, but might include goal type (time, distance and calories), level, age, weight, distance, and target heart rate* (for heart rate programs).

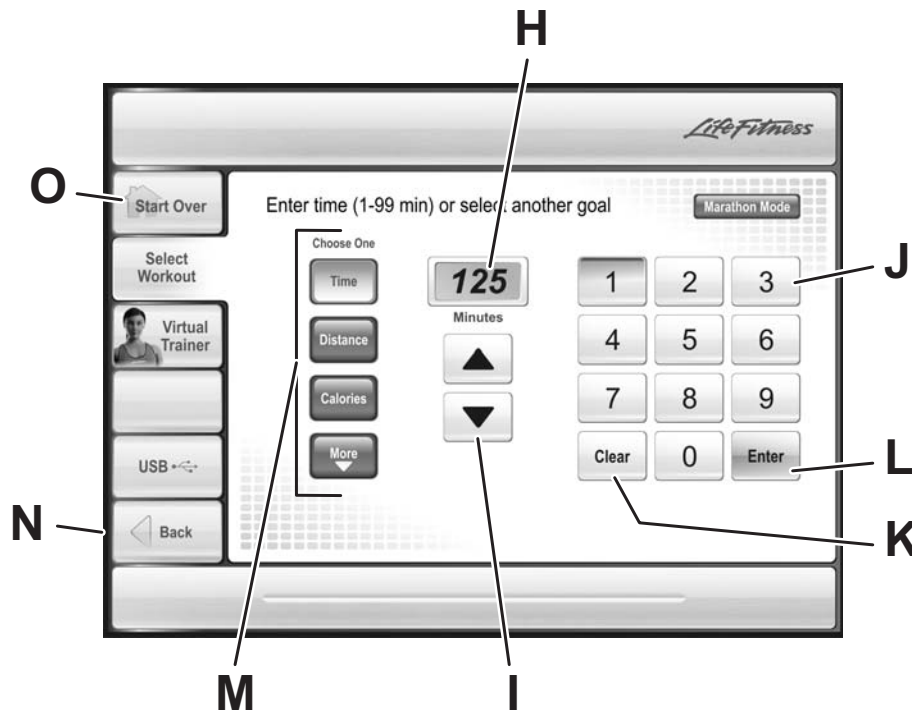

- H. DATA DISPLAY: Displays the data input value.
- I. ARROW BUTTONS: Use the UP and DOWN arrows to adjust workout values/goals such as length of workout, weight, age, distance, target heart rate, and resistance level. Press ENTER to record the selection.
- J. NUMERIC KEYPAD: Another way for the user to enter workout parameters. Key in the desired number on the keypad and press ENTER.
- K. CLEAR: Clears any entry and returns to the default setting.
- L. ENTER: Press this button after entering a value to register the value and move to the next screen.
- M. GOAL TYPE: Select a desired workout goal type. Choose from Time, Distance, Calories, Pace, Time in Zone or Marathon Mode (if enabled).
- N. BACK: Returns to the previous screen.
- O. START OVER: Exits workout setup and returns to the Home Screen.

* Target Heart Rate (THR) is a percentage of the theoretical maximum. For example, a 40-year-old user's THR for the **FAT BURN** workout is 117. This workout targets 65 percent of the maximum, so the equation would be $(220-40) \cdot 65 = 117$.

TYPES OF WORKOUT SETUP SCREENS

GOAL SETUP SCREENS

- **Goal Type:** The default setting of Goal Type is TIME (length of workout) allowing the user to set a predetermined length of time for the workout.

Users may also choose a more advanced Goal Type such as DISTANCE, CALORIES, or TIME IN ZONE (only available for heart rate programs).

For Distance, Calories, Pace, and Time in Zone, the length of the workout depends on how long it takes to reach the goal. The workout continues until the goal is met. To exit early, either choose COOL DOWN from the bottom of the display to go immediately into the cool down phase, or choose CHANGE WORKOUT to access a different program. For more information, see Section 4.2, *Using the Workouts, Selecting a Goal Type*.

For information on how to set, and get maximum benefit from, these type of workout goals consult a Personal Trainer. For further information on Zone Training see section 3.1, *Why Heart Rate Zone Training Exercise?*

- **Level:** Choose the programmed resistance level of the workout. Levels range from 1 to 25.
- **Target Heart Rate*:** (heart rate workouts only) Gives a recommended heart rate according to age. For **Fat Burn**, the target heart rate is computed at 65% of the theoretical maximum[†] heart rate. For **Cardio**, the target heart rate is computed at 80%. For more information on Target Heart Rate, see Section 3, *Heart Rate Zone Training Exercise*.

VALUE SETUP SCREENS

- **Weight:** Entering an accurate weight allows calories to be calculated, and enables Calories Burned, Calories per Hour, and METs to appear on the Workout Screen.
- **Age:** Allows heart rate programs to accurately determine target heart rate.
- **Gender:** Used in the Fit Test prediction equation and associated fitness rating.

[†] Defined by the American College of Sports Medicine's "Guidelines for Exercise Testing and Prescription" as equal to 220 minus an individual's age.

* Target Heart Rate (THR) is a percentage of the theoretical maximum (HRmax). A 40-year-old user's recommended THR for the **HEART RATE HILL** and **HEART RATE INTERVAL** workouts is 144, or 80 percent of the maximum; so the equation would be $(220-40) \cdot .80 = 144$.

4) WORKOUT PROGRESS

The Workout Progress screen opens automatically upon completion of the setup, signaling the user to start the workout. This screen allows the user to monitor the progress of the workout. It provides a visual representation of the workout as it proceeds and monitors distance, pace, elapsed time, heart rate, level, speed, Watts/METs, and calories expended/calories per hour.

From the Workout Progress Screen, goals including Time, Level, and Target Heart Rate* (for heart rate programs) can be changed at any point during the workout. This screen also accesses TV viewing. Not every goal item is available in every workout. Only valid goal times are shown and accessible in the workout progress screen during a workout.

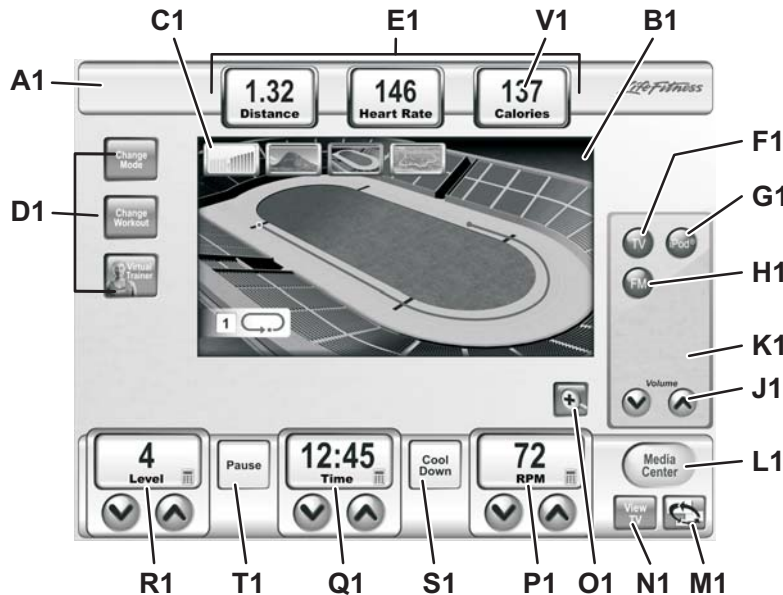

A1. WORKOUT LABEL / MINI PROFILE AREA: Shows the user the workout type, shows a miniature profile when media is active and covering the main profile area.

B1. WORKOUT PROFILE WINDOW: This window displays workout progress using one of four workout landscapes.

C1. WORKOUT LANDSCAPE SELECTION BUTTONS: These buttons allow the user to toggle between four workout landscapes; CLASSIC PROFILE, MOUNTAIN, 400-METER TRACK and 5K NATURE TRAIL. These can be toggled between at will without losing workout progress information.

D1. ON-THE-FLY BUTTONS: Enables users to access workout change or workout information during a workout without losing workout progress.

CHANGE MODE: Choose this button to switch between the Cross-Train Aerobics and Cross-Train Reverse modes.

CHANGE WORKOUT: Choose this button to go back to the SELECT WORKOUT screen and choose a new workout, or to change a goal type or value, while retaining workout progress. To change workouts, choose the new program, enter any remaining values, and press ENTER.

To return to the current workout without making any changes, choose BACK. Select the RESET button on the workout selection screen to clear all the stored information about the current workout, before changing to a new program.

VIRTUAL TRAINER: Choose this button to enable or disable the VIRTUAL TRAINER.

E1. GOAL DISPLAYS:

HEART RATE: (replaces level on heart rate workouts only) Displays the target heart rate* the user has specified in the workout setup screens. Can be changed anytime during a workout, by using the arrow keys directly below it, or by touching the HEART RATE button on the Touchscreen, and accessing the Target Heart Rate Workout Setup Screen.

ACTUAL HEART RATE: Displays the heart rate if the user grasps the Lifepulse sensors or wears a Polar-compatible heart rate chest strap. **NOTE:** Heart rate can be checked on any of the screens, whether before a workout begins, or during a workout.

DISTANCE: Displays the accumulated distance traveled during a workout.

CALORIES: Displays the accumulated calories burned.

* Target Heart Rate (THR) is a percentage of the theoretical maximum (HRmax). A 40-year-old user's recommended THR for the **HEART RATE HILL** and **HEART RATE INTERVAL** workouts is 144, or 80 percent of the maximum; so the equation would be $(220-40) \times .80 = 144$.

- F1.** TV SELECTION: TV ON/OFF: If enabled, use to access TV viewing. See Section 5.2, *Configuration Menu, Manager's Configuration 2, TV / FM Radio*, for more information.
- G1.** iPod SELECTION: If detected, use to access an iPod media device. Once detected, the iPod menus can be navigated on the Touchscreen Display. The unit is capable of playing both music and video.
- NOTE:** Headphones must be plugged into the Cross-Trainer to access the sound for the iPod. The jack is located on the bottom of the Options Panel. If the jack is faulty, the Options Panel needs to be replaced. Contact Life Fitness Customer Support Services for more information. (See page 1 for contact information.)
- H1.** FM SELECTION: FM ON/OFF: If enabled, use to access FM Radio. See Section 5.2, *Configuration Menu, Manager's Configuration 2, TV / FM Radio*, for more information.
- J1.** VOLUME: Volume control for all media and system sounds.
- NOTE:** Headphones must be plugged into the Cross-Trainer to access the sound for all media options. The jack is located on the bottom of the Options Panel. If the jack is faulty, the Options Panel needs to be replaced. Contact Life Fitness Customer Support Services for more information. (See page 1 for contact information.)
- K1.** CHANNEL: Channel control for the TV.
- L1.** MEDIA CENTER: Allows the user to access TV controls when the TV is viewed at full screen. The media center will appear over the TV picture. It will automatically close after 10 seconds of idle time.
- M1.** TV SIZE TOGGLE: Enables the user to toggle through three sizes of TV display.
- N1.** VIEW PROFILE / TV TOGGLE: Enables the user to toggle between the workout profile and TV display.
- O1.** ZOOM BUTTON: Select this button to view Level, Time, and Speed in a large, easy to read display. The workout profile is not viewable while ZOOM mode is active.
- P1.** SPEED DISPLAY: The Speed Display shows the pedaling speed or rate in miles per hour (or kilometers per hour if enabled).
- Q1.** TIME DISPLAY: Select this button to view the time of day, change the length of the workout or to choose a different view for time. To change workout length, select ELAPSED TIME, use the arrow buttons or the numeric keypad to adjust the time, and then select ENTER. To change the time view, select ELAPSED TIME, choose a different time view (REMAINING TIME or HIDDEN TIME) and press ENTER.
- To change the length of a workout without leaving the workout progress screen, use the arrow keys on the Touchscreen Display directly underneath ELAPSED TIME.
- NOTE:** Changing the length of a workout by using the TIME ELAPSED button has no effect on the time elapsed, which is an ongoing measurement of the time already spent in a workout.
- R1.** LEVEL DISPLAY: Adjust the resistance level of the workout. Choose between 25 resistance levels.
- S1.** COOL DOWN: Workout programs end automatically in a cool down phase, which lowers the intensity level. In this phase of a workout the body begins to remove lactic acid and other accumulated by-products of exercise, which build up in muscles during a workout and contribute to muscle soreness.
- Press the COOL DOWN key to enter the cool down stage at any point during the workout. Each workout's cool down level is automatically adjusted according to the individual user's performance. (Cool down times are preset in proportion to the duration of a workout.) The cool down time can be changed by using the corresponding arrow keys on the Touchscreen Display. At the end of cool down, a workout summary box appears.
- T1.** PAUSE: Press this key to pause the current workout. A RESUME WORKOUT button and EXIT button appear on the Touchscreen. Continue the workout by selecting RESUME WORKOUT or end the workout by selecting EXIT.
- NOTE:** The workout will also pause if the user stops pedaling. To continue the workout, resume pedaling. The pause duration lasts 60 seconds, after which the console automatically shuts down.
- U1.** WORKOUT STATISTICS: Continually updates workout progress by showing Distance, Distance Climbed, Pace in minutes per mile/kilometer, Calories Expended/Calories per Hour, Target Heart Rate (for heart rate programs), Heart Rate (on any workout if the user is grasping the Lifepulse sensors or wearing a telemetry strap), Time in Zone (if selected as a workout goal) and METs/Watts (toggles between the two if weight has been entered, otherwise only shows Watts).
- The following data can be toggled: Calories, Calories per Hour, Watts, and METs. To customize the toggled information, press the data display button to access a separate menu. All four choices, along with check boxes, will appear. Checkmarks indicate which choices will be toggled. For example, if Calories is the only display desired, uncheck the other three choices. If both Calories and Calories per Hour are desired, uncheck the other two choices. When finished making the selection, hit CLOSE. Select HIDE ALL to hide all choices.
- Changeable information either appears as a button (Time, Level, and Target Heart Rate) or is accessible through CHANGE WORKOUT.

4) TV

If Favorites and/or Channel List options are enabled, an Options menu will be enabled for selecting a desired channel selection interface.

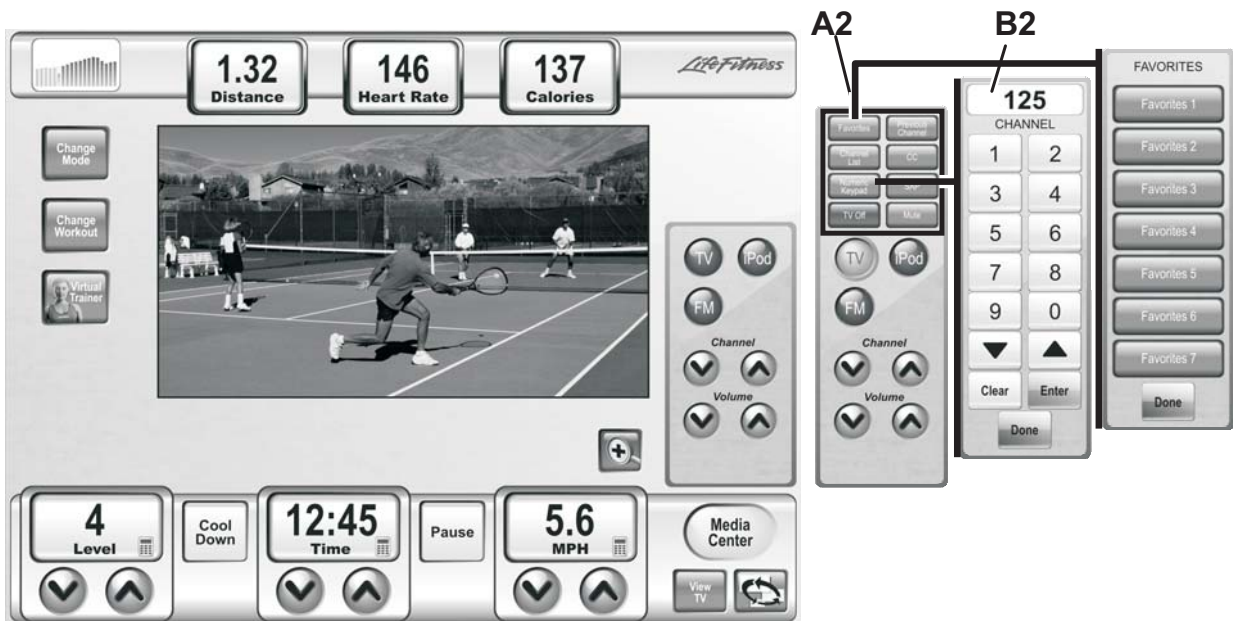

A2. TV CONTROLS: Use to access TV viewing options.

FAVORITES: If enabled, use to toggle to Favorite Channel selection menu. The Favorites menu will stay visible as long as buttons are actively pressed. The menu will automatically disappear after 10 seconds of idle time. See Section 5.2 *Configuration Menu, Manager's Configuration 2, TV/FM Radio*, for more information.

CHANNELS LIST: If enabled, use to toggle to Channel List selection menu. The Channel List menu will stay visible as long as buttons are actively pressed. The menu will automatically disappear after 10 seconds of idle time. See Section 5.2 *Configuration Menu, Manager's Configuration 2, TV/FM Radio*, for more information.

NUMERIC KEYPAD: Press to access the NUMERIC KEYPAD for manual channel input. The NUMERIC KEYPAD will stay visible as long as buttons are actively pressed. The menu will automatically disappear after 10 seconds of idle time.

PREVIOUS CHANNEL: Press to jump to the last TV channel viewed.

SAP (SECONDARY AUDIO PROGRAMMING): Press to activate Secondary Audio Programming when available.

MUTE: Press to silence the audio of the TV.

TV OFF: Press to turn TV viewing off.

CC: Press to activate Closed Captioning.

B2. CURRENT CHANNEL / NOW PLAYING: Displays the current TV or FM channel name. If iPod is active, the name and artist of the currently playing song or movie is displayed.

5) FM



- E2.** FM CONTROLS: Use to access pre-set FM Radio stations. Use the SCAN and SEEK buttons to browse available stations. See Section 5.2 *Configuration Menu, Manager's Configuration 2, TV / FM Radio*, for more information.
- F2.** NUMERIC KEYPAD: Press this button to view a numeric keypad and enter stations manually.
- G2.** HIDE FM RADIO: Press this button to hide the FM display to view the workout profile. Hiding the playlist does not turn off the FM playback.
- H2.** FM RADIO OFF: Press this button to turn FM radio off.

6) iPod



- I2.** iPod CONTROLS: If detected, use to access iPod data. Use the controls next to the menu item list to navigate through categories, songs, movies, etc. Press SELECT to accept the highlighted list item.
- J2.** HIDE PLAYLIST: Press this button to hide the iPod playlist to view the workout profile. Hiding the playlist does not turn off the iPod.

Additional information appearing in the Workout Progress Screen for different workouts:

ENTER WEIGHT: Appears in the Quick Start workout. Choose ENTER WEIGHT FOR ACCURATE CALORIES so that METs and Calories Burned/Calories per Hour can be computed and displayed as workout statistics.

TIME IN ZONE: Displays the accumulated time that the heart rate stays within the selected target zone for a Heart Rate Zone Training workout. See Section 3, *Heart Rate Zone Training Exercise*, for more information.

PACE DISPLAY: Allows the user to track whether his or her pace is ahead, behind or on target with his or her desired pace.

2.3 READING RACK AND ACCESSORY TRAYS

A built-in reading rack (A) allows a book or magazine to be supported during the workout. A built-in accessory tray (B) provides storage for items such as water bottles, personal media devices, and cell phones.

NOTE: Since reading materials will be in front of the Touchscreen Display, use care when placing reading materials on the rack, and when turning pages, to ensure that buttons aren't accidentally toggled.

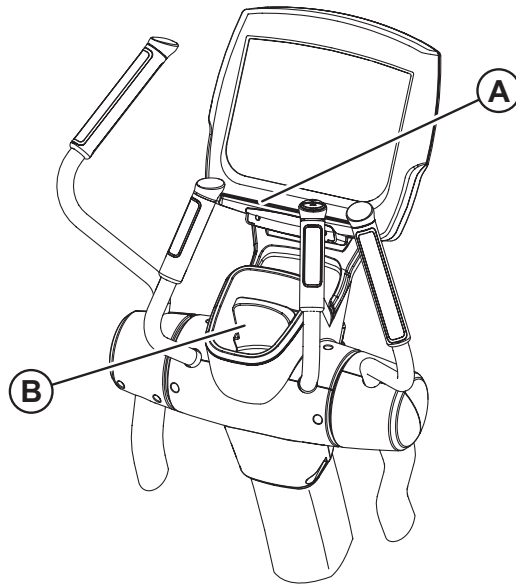

3 HEART RATE ZONE TRAINING EXERCISE

3.1 WHY HEART RATE ZONE TRAINING EXERCISE?

Research shows that maintaining a specific heart rate while exercising is the optimal way to monitor the intensity of a workout and to achieve maximum results. That is the idea behind the Life Fitness Heart Rate Zone Training approach to exercise.

Zone Training identifies an exerciser's ideal heart rate range, or zone, for burning fat or increasing cardiovascular fitness. The zone is a percentage of the theoretical maximum[†] (HRmax), and its value depends on the workout. The Life Fitness Cross-Trainer features five exclusive workouts designed to take full advantage of the benefits of Heart Rate Zone Training exercise:

- FAT BURN
- HEART RATE HILL
- EXTREME HEART RATE
- CARDIO
- HEART RATE INTERVAL

Each workout offers different benefits, as discussed in Section 4, *The Workouts*.

NOTE: Consulting a fitness trainer is recommended for defining specific fitness goals and designing a workout program.

The Heart Rate Zone Training workout programs measure heart rate. Wear the optional telemetry chest strap, or grip the Lifepulse sensors, to enable the cross-trainer's on-board computer to monitor the heart rate during a workout. The computer automatically adjusts the resistance level to maintain the target heart rate* based on the actual heart rate.

To change the target heart rate during a workout, simply enter a new target heart rate either by typing in the desired number on the keypad or by pressing the Heart Rate button on the Touchscreen.

To switch between programs during a workout, use the CHANGE WORKOUT button.

ZONE TRAINING		
FAT BURN = LOW INTENSITY		
CARDIO = HIGH INTENSITY		
AGE	65%	80%
10	136	168
20	130	160
30	123	152
40	117	144
50	110	136
60	104	128
70	97	120
80	91	112
90	84	104
100	78	96

SUGGESTED TARGET HEART RATE AS % OF MAX ACSM HEART RATE RANGE: 55% - 90%

[†] Defined by the American College of Sports Medicine's "Guidelines for Exercise Testing and Prescription" as equal to 220 minus an individual's age.

Target Heart Rate (THR) is a percentage of the theoretical maximum. For example, a 40-year-old user's THR for the **FAT BURN** workout is 117. This workout targets 65 percent of the maximum, so the equation would be $(220-40) \cdot 65 = 117$.

3.2 HEART RATE MONITORING

THE LIFEPUULSE™ DIGITAL HEART RATE MONITORING SYSTEM

The patented Lifepulse system sensors are the built-in heart rate monitoring system. For the most accurate reading possible, during a workout:

- Grasp the sensors (A) on the arms or bull horns firmly.
- Hold each sensor at the vertical midpoint.
- Keep hands steady and in place.

The console displays the heart rate within 10 to 40 seconds after the user grasps the sensors.

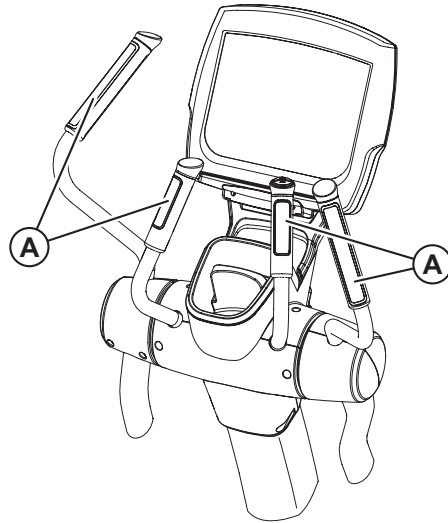

NOTE: *Sensors are located on both the arms and bull horns.*

3.2 HEART RATE MONITORING

THE OPTIONAL HEART RATE CHEST STRAP

The Life Fitness Cross-Trainer is equipped with Polar® telemetry, a heart rate monitoring system in which electrodes, pressed against the skin, transfer heart rate signals to the cross-trainer console. These electrodes are attached to a chest strap that the user wears during the workout. The chest strap is optional. To order it, call Life Fitness Customer Support Services at 1-800-351-3737.

See the diagram below for correct positioning of the strap. The electrodes (A), which are the two grooved surfaces on the underside of the strap, must remain wet to transmit accurately the electrical impulses of the heart back to the receiver. Moisten the electrodes. Then, secure the strap as high under the chest muscles as possible. The strap should be snug, but comfortable enough to allow for normal breathing.

The transmitter strap delivers the most accurate heart rate reading when the electrodes are in direct contact with bare skin. However, it functions properly through a thin layer of wet clothing.

If it becomes necessary to re-moisten the chest strap electrodes, grasp the center of the strap, pull it away from the chest to expose the two electrodes, and re-moisten them.

NOTE: *If the Lifepulse system sensors are grasped while the chest strap is worn, and if the signals from the sensors are valid, the on-board computer uses the sensor signals for measuring the heart rate instead of those transmitted with the chest strap.*

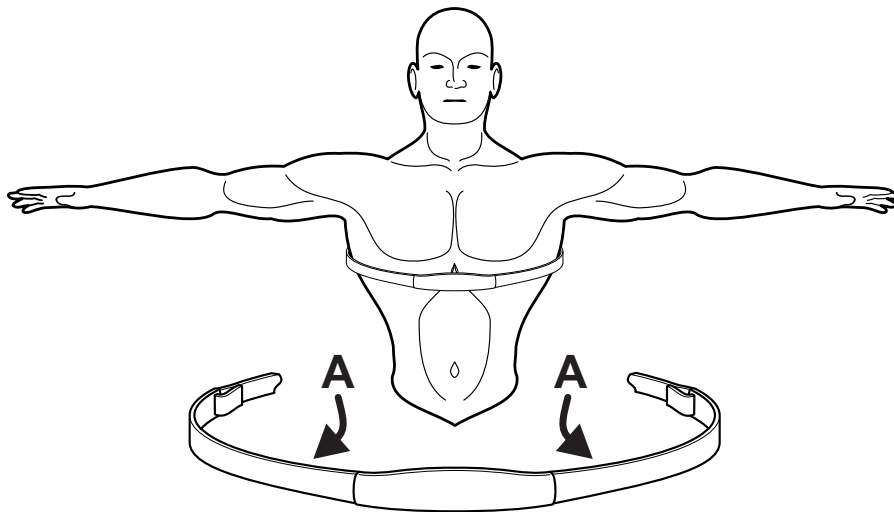

4 THE WORKOUTS

4.1 WORKOUT OVERVIEWS

The following workouts are preprogrammed for the Life Fitness Cross-Trainer.

QUICK START is the fastest way to begin exercising and it bypasses the steps involved in selecting a specific workout program. After the QUICK START key is pressed, a constant level workout begins. The intensity level does not change automatically. To change the level, use the LEVEL ARROW keys or the NUMERIC KEYPAD to enter a higher or lower level number. After the workout has been in progress for 12 seconds, the touchscreen displays "ENTER WEIGHT", which the computer requires to calculate total calories. Using the ARROW KEYS, increase or decrease the displayed weight to the correct value (or enter the weight using the NUMERIC KEYPAD).

CLASSIC WORKOUTS

CLASSIC WORKOUTS are workouts in which intensity levels increase and decrease in set patterns. The following workouts may be accessed with this button:

MANUAL is a constant effort workout in which the user can change resistance level or speed at any time.

RANDOM is an interval training workout of constantly changing intensity levels that occur in no regular pattern or progression.

HILL is an interval training workout. Intervals are periods of intense aerobic exercise separated by regular periods of lower-intensity exercise.

CROSS-TRAIN AEROBICS simulates the experience of working with a personal trainer. The Message Area displays prompts at different times to emphasize pushing, pulling, total body, lower body, speed changes, and forward/reverse motion. This versatile workout promotes maximum cross-training benefits.

CROSS-TRAIN REVERSE continuously alternates five minutes of forward motion with two minutes of backward motion to cross-train different muscle groups.

HEART RATE + WORKOUTS

HEART RATE + workouts are workouts in which intensity levels increase and decrease in set patterns. The following workouts may be accessed with this button:

FAT BURN is a low-intensity workout for burning the body's fat reserves. The user wears a heart rate chest strap, or grasps the Lifepulse sensors continuously. The program adjusts the intensity level through changing the incline (elevation), based on the actual heart rate, to maintain the rate at 65 percent of the theoretical maximum[†].

CARDIO is a higher intensity workout for more fit users, emphasizing cardiovascular benefits and maximum fat burning. The user wears a heart rate chest strap, or grasps the Lifepulse sensors continuously. The program adjusts the intensity level, based on the actual heart rate, to maintain the rate at 80 percent of the theoretical maximum.

HEART RATE HILL takes the user through three different hills based on the target heart rate*. The user wears a heart rate chest strap, or grasps the Lifepulse sensors continuously.

HEART RATE INTERVAL alternates between a hill and a valley based on the target heart rate*. The user wears a heart rate chest strap, or grasps the Lifepulse sensors continuously.

EXTREME HEART RATE is an intense workout for more experienced users. It is designed to get the heart rate up and down as quickly as possible. The user wears a heart rate chest strap, or grasps the Lifepulse sensors continuously.

[†] Defined by the American College of Sports Medicine's "Guidelines for Exercise Testing and Prescription" as equal to 220 minus an individual's age.

* Target Heart Rate (THR) is a percentage of the theoretical maximum (HRmax). A 40-year-old user's recommended THR for the **HEART RATE HILL** and **HEART RATE INTERVAL** workouts is 144, or 80 percent of the maximum; so the equation would be $(220-40) \times .80 = 144$.

HILL + WORKOUTS

HILL PLUS are workouts in which intensity levels increase and decrease in set patterns. The following workouts may be accessed with this button:

AROUND THE WORLD is an interval-training workout in which the hills resemble scenes of various geographical areas.

CASCADES is a two-peak workout in which intensity levels gradually increase and decrease.

FOOTHILLS is a rolling hill workout with low intensity levels.

KILIMANJARO is a Hill workout in which the intensity levels gradually incline toward one ultimate peak and then gradually decline.

ADVANCED WORKOUTS

ADVANCED WORKOUTS are customized workouts designed for the advanced user not used in connection with a personal trainer. These workouts include:

FIT TEST predicts cardiovascular fitness compared to other people of the same age and gender.

CREATE YOUR OWN

CREATE YOUR OWN workouts enable the user to design personalized workouts based on **HEART RATE INTERVAL** and **LEVEL INTERVAL**.

CUSTOM

CUSTOM WORKOUTS allow the user to select from four custom **HEART RATE INTERVAL** workouts and four custom **LEVEL INTERVAL** workouts pre-defined by the facility fitness professional.

4.2 USING THE WORKOUTS

Select a workout. See the chart at the beginning of Section 4.3 for an overview of the steps required to set up each workout.

1) BEGINNING A WORKOUT

There are three ways to begin a workout: Quick Start, Select Workout (see Section 4.22) and Virtual Trainer (see Section 4.5).

SELECTING AND USING QUICK START

QUICK START is the fastest way to begin exercising. It bypasses the steps of selecting a specific workout program. On the home screen, press the QUICK START button. The workout begins at an intensity level that remains the same unless manually changed. Choose ENTER WEIGHT so that METs and Calories Burned/Calories per Hour can be computed and displayed as workout statistics.

2) SELECTING A WORKOUT

Press the select workout button to begin the workout selection process. The touchscreen will bring up the top level workout categories which include Classic, Heart Rate +, Hill + and Advanced. Each workout button includes a listing of workout programs or an easy to understand description of the workout. Once a workout is selected, the corresponding Workout Setup Screens which include goal type (time, distance, calories, and pace), level, age, weight, distance, and target heart rate* will appear. Press ENTER after each selection to record it. After values are set, the workout progress screen appears and the workout begins.

See section 4.3 for detailed information on available workouts.

3) ENTERING WORKOUT GOALS

SELECTING A GOAL TYPE

Goal Type defaults to TIME (length of workout.) When prompted to enter a Goal Time, use the ARROW KEYS to increase or decrease the displayed time to the desired value, or key in the desired value with the NUMERIC KEYPAD, and press ENTER.

Workouts can be programmed to target advanced goals other than the default time goal:

- DISTANCE
- CALORIES
- PACE
- TIME IN ZONE (for heart rate workouts only)

The **Distance Goal** feature is designed to build endurance. The user sets a distance goal during the workout setup. Once the goal is met, the workout automatically goes into a cool down phase and ends afterward. To use this feature:

1. Select a workout.
2. In the Goal Type setup screen, choose DISTANCE, enter the desired distance goal, and select ENTER.
3. Finish the setup steps for the selected workout.
4. Begin the workout.

The **Calories Goal** feature is designed to promote weight loss and weight control. The user sets a calorie goal during the workout setup. Once the goal is met, the workout automatically goes into a cool down phase and ends afterward. To use this feature:

1. Select a workout.
2. In the Goal Time setup screen, choose CALORIES, enter the desired calorie goal, and select ENTER.
3. Finish the setup steps for the selected workout.
4. Begin the workout.

The **Pace Goal** feature is designed to allow the user to set the pace of a workout. The user sets a pace goal during the workout setup. Once the goal is met, the workout automatically goes into a cool down phase and ends afterward. A pace readout is displayed at the left of the screen showing numeric feedback regarding the user's progress relating to the selected pace. To use this feature:

1. Select a workout.
2. In the Goal Time setup screen, choose MORE, select PACE, enter the desired pace goal, and select ENTER.
3. For Units, choose either ENGLISH (to set a pace speed in miles/time) or METRIC (to set a pace speed in kilometers/time).
4. Enter the distance and time of the workout.
5. The console will calculate the pace the user must maintain to finish the workout in the desired time.
6. Select ENTER to approve the displayed pace or reenter the chosen time and distance.
7. Begin the workout.

The **Time in Zone Goal** program enhances a workout by setting a certain duration within the target heart rate* as a workout goal. The program automatically alters the resistance to maintain a pace that will meet that objective within that duration. Once the objective is met, the workout automatically goes into a cool down phase. To use the Time In Zone Goal feature:

1. Select a workout.
2. In the Goal Time setup screen, choose TIME IN ZONE (some workouts require the user to choose the MORE option first), enter the desired amount of time, and select ENTER.
3. Finish the setup steps for the selected workout.
4. Begin the workout.

NOTE: Time in Zone is directly correlated to fitness level. Since the program will continue to increase resistance until the goal is met, it may be wise to start low and work towards a higher goal. Choose COOL DOWN at any time, to exit the workout and immediately enter a cool down phase.

For help setting TIME IN ZONE goals, consult a personal trainer. For more information on Heart Rate Zone Training, see Section 3.1, *Why Heart Rate Zone Training?*

RESISTANCE LEVEL

The Life Fitness Cross-Trainer provides several different ways to adjust the resistance level of a workout. When prompted, use the ARROW keys to increase or decrease the displayed resistance level or target heart rate* to the desired value, or choose the desired value with the NUMERIC KEYPAD, and press ENTER. Adjust the level as needed or desired during the workout.

- Resistance level: The Life Fitness Cross-Trainer provides a selection of 25 resistance levels. The resistance level appears in the WORKOUT PROFILE window as rows of lights arranged in columns. Selecting a low intensity level at first is recommended. As physical conditioning improves, the levels can increase.

TARGET HEART RATE

- Target heart rate: Programs that calculate a target heart rate* base this number on the age of the user and the type of workout. The user accepts or adjusts the rate when setting up the workout. During the workout itself, the program reads the heart rate, which is transmitted via the Polar heart rate chest strap or the Lifepulse system sensors; and it uses this data to adjust the resistance. Manually raising the rate increases the intensity of the cardiovascular exercise.

* Target Heart Rate (THR) is a percentage of the theoretical maximum. For example, a 40-year-old user's THR for the **FAT BURN** workout is 117. This workout targets 65 percent of the maximum, so the equation would be $(220-40) \times .65 = 117$

4) ENTERING WORKOUT VALUES

AGE: When prompted to enter Age, use the ARROW KEYS to increase or decrease the displayed age to the correct value, or key in the correct value with the NUMERIC KEYPAD, and press ENTER.

Life Fitness Cross-Trainer workout programs that set a target heart rate* zone first calculate the user's theoretical maximum heart rate[†] by subtracting the user's age from the number 220. The programs then calculate the target zone as a percentage of the theoretical maximum.

WEIGHT: Select weight and press ENTER. Entering an accurate weight allows for a more accurate calorie calculation and for METs to be computed and displayed. The on-board computer calculates the number and rate of calories burned using the entered weight as well as the pedaling speed.

GENDER: Select gender and press ENTER. (Used for the Fit Test).

5) USING MARATHON MODE

If Marathon Mode is enabled, a Marathon Mode button will appear in the time entry screen when configuring a workout. Selecting Marathon Mode sets the workout to an unlimited time workout. The workout can then be ended only by the user or one of the emergency stop systems.

Within a workout, Marathon Mode can be changed by pressing the Time Key. Pressing the Time Key makes it possible to set a time goal as long as it's not less than the time already spent in the workout. A new time goal must be set and entered to override Marathon Mode.

6) CHANGING/ENDING A WORKOUT

SWITCHING WORKOUTS "ON-THE-FLY"

It is possible during a workout, to switch to another workout program. After a switch, the console retains all the progress information about the workout since its beginning. To change workouts "on the fly," simply press CHANGE WORKOUT and then choose a new workout. To switch to a new workout, and restart the progress information, choose CHANGE WORKOUT and then RESET. To switch between Cross-Train Aerobics and Cross-Train Reverse, choose CHANGE MODE.

PAUSING WORKOUTS

Press the PAUSE key or stop pedaling to hold the current workout. A RESUME WORKOUT button and EXIT button appear on the Touchscreen. Continue the workout by selecting RESUME. The pause duration defaults to 1 minute (configurable by the manager), after which, the console returns to the Home Screen. End the workout by selecting EXIT.

ENDING WORKOUTS EARLY

To end a workout early, press COOL DOWN on the bottom of the Touchscreen to go directly into the cool down phase. The COOL DOWN button changes into an END WORKOUT button. A user can stop a workout by pushing the END WORKOUT button; otherwise the cool down phase will automatically begin. The program will designate a cool down time period in proportion to the amount of time spent in the workout. Upon completion of cool down, the Workout Summary screen will appear. To exit the program without a cool down press the STOP button or select CHANGE PROGRAM, and then RESET.

WORKOUT SUMMARY

Upon ending a workout, a workout summary will appear. The workout summary information displayed depends on the workout selected. Information may include: Average Level, Distance, Distance Climbed, Calories Burned, Average Heart Rate and Elapsed Time. The duration of the Workout Summary screen defaults to 1 minute. To extend the screen time, press the More Time button to reset the counter to 1 minute. Workout summary data can be saved to a USB stick for use in future review and tracking.

[†] Defined by the American College of Sports Medicine's "Guidelines for Exercise Testing and Prescription" as equal to 220 minus an individual's age.

* Target Heart Rate (THR) is a percentage of the theoretical maximum. For example, a 40-year-old user's THR for the **CARDIO** workout is 144. This workout targets 80 percent of the maximum, so the equation would be $(220-40) \times .80 = 144$.

4.3 WORKOUT DESCRIPTIONS

WORKOUT HIERARCHY

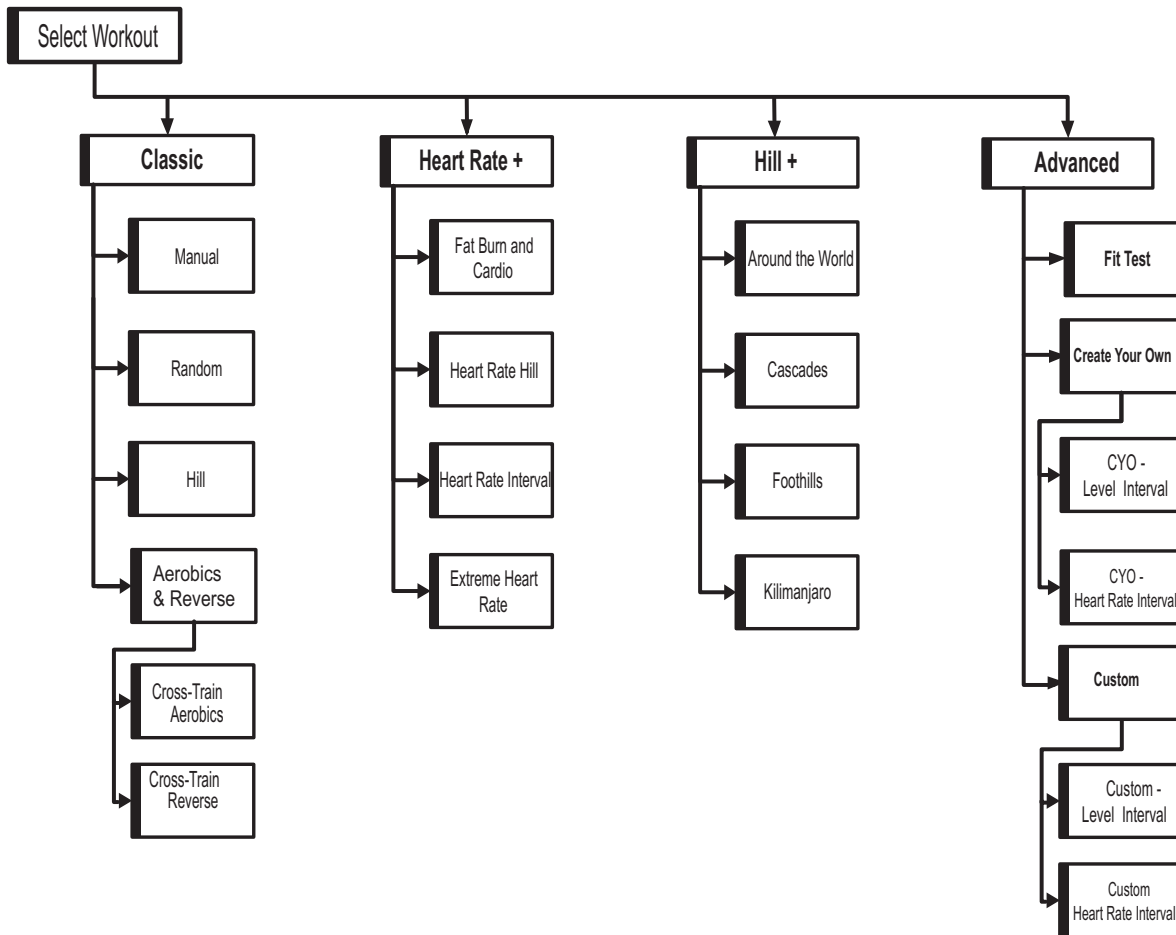

4.3 WORKOUT DESCRIPTIONS

QUICK START

QUICK START is the fastest way to begin exercising, and it bypasses the specific steps of selecting a specific workout program. After pressing the QUICK START button (Touchscreen Display), a MANUAL workout begins. For METs and Calories Burned/Calories per Hour to be computed and displayed during a workout, select the ENTER WEIGHT button which is required to calculate these values.

The level is set to the minimum level. To change the level and stay in the Workout Progress screen, press the LEVEL button or the corresponding UP and DOWN ARROW KEYS on the Touchscreen Display.

CLASSIC WORKOUTS

MANUAL

The **MANUAL** program is a constant effort workout in which the user can change resistance level at any time.

RANDOM

The **RANDOM** program creates a terrain of hills and valleys that varies with each workout. More than one million different patterns are possible.

CROSS-TRAIN AEROBICS

During this workout, the Message Area displays prompts to emphasize different muscle groups. To emphasize upper-body muscles, the Message Area displays prompts to focus on pushing and pulling the moving arms at various times. To emphasize lower-body muscles, the Message Area displays prompts to rest the hands on the stationary handlebar, thus forcing the legs to do all the work. The program also alternates between forward and reverse motion as well as different speeds.

Ten seconds after prompting the user to change pedaling direction, the workout applies "braking resistance," that is, a high resistance level that essentially forces the user to stop pedaling. Once the user stops pedaling, the workout resumes the normal resistance level. The actual level of braking resistance depends on the user's pedaling speed. If the user is pedaling at a rate equal to, or faster than 6.2 mph (10.0 km/h), the workout applies the maximum level of braking resistance. If the user is pedaling at a speed below 6.2 mph (10.0 km/h), the workout applies 92 percent of the maximum.

CROSS-TRAIN REVERSE

This workout features alternating periods of pedaling forward and pedaling backwards. If the user chooses a workout duration 14 minutes or above, the unit displays alternating prompts to pedal forward for five minutes and then backward for two minutes. If the user selects a goal of 13 minutes or below, the display prompts the user to pedal forward for two minutes and then backward for one minute. If the user selects a goal other than time (distance or calorie), the program uses the default setting of prompting forward motion for five minutes and reverse for two minutes.

This feature varies the emphasis on different leg muscles. Ten seconds after prompting the user to change pedaling direction, the workout applies "braking resistance," that is, a high resistance level that essentially forces the user to stop pedaling. Once the user stops pedaling, the workout resumes the normal resistance level. The actual level of braking resistance depends on the user's pedaling SPEED. If the user is pedaling at a rate equal to, or faster than, 6.2 mph (10.0 km/h), the workout applies the maximum level of braking resistance. If the user is pedaling at a speed below 6.2 mph (10.0 km/h), the workout applies 92 percent of the maximum.

HILL

The Life Fitness-patented **HILL** workout offers a variety of configurations for interval training. Intervals are periods of intense cardiovascular exercise separated by regular periods of lower-intensity exercise. The **CLASSIC PROFILE WINDOW** represents these high and low intervals as columns of light, which together have the appearance of hills and valleys. The computerized interval training workout has been scientifically demonstrated to promote greater cardiorespiratory improvement than steady-pace training.

The **HILL** workout goes through four phases, each marked by different intensity levels. The **CLASSIC PROFILE WINDOW** displays the progress of these phases. As noted in the descriptions below, the heart rate should be measured at two stages in the workout to gauge its effectiveness. Wear the chest strap or continuously grip the Lifepulse™ handles. The Message Area does not display a request for a heart rate measurement, as it does with **CARDIO**, **FAT BURN** and the **HEART RATE ZONE TRAINING** programs.

- 1 **Warm-up** is a phase of low, gradually rising resistance, which brings the heart rate into the lower end of the target zone and increases respiration and blood flow to working muscles.
- 2 **Plateau** increases the intensity slightly, and keeps it steady, to bring the heart rate to the low end of the target zone. Check the heart rate at the end of this phase.
- 3 **Interval Training** is a series of increasingly steeper hills, alternating with valleys, or stints of recovery. The heart rate should rise to the high end of the target zone. Check the heart rate at the end of this phase.
- 3 **Cool-down** is a low-intensity phase that allows the body to begin removing lactic acid, and other exercise by-products, which build up in muscles and contribute to soreness.

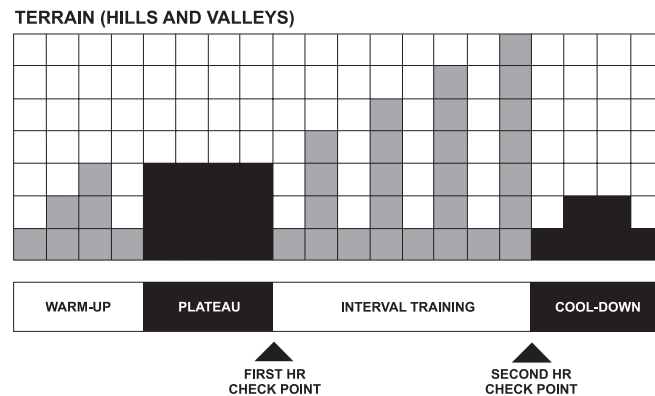

Each column, as seen in the **CLASSIC PROFILE WINDOW** and the chart above, represents one interval. The overall duration of the workout determines the length of each interval. Each workout is made up of 20 intervals, so the duration of each interval is equal to the duration of the entire workout divided by 20.

1 to 9 minutes: A workout with a duration of less than 10 minutes is insufficient for the **HILL** program to complete all four phases adequately. The program, therefore, condenses a workout of this duration at various stages.

10 to 19 minutes: The interval durations initially are set at 30 seconds for a 10-minute workout. For every minute over 10, each interval increases by three seconds. A 15-minute workout consists of 20 intervals at 45 seconds each.

20 to 99 minutes: All intervals last 60 seconds. If the user adds minutes to the pre-set duration while the workout is in progress, the program adds hills and valleys that are identical to the first eight intervals of the Interval Training phase. This pattern repeats until the workout is completed.

HEART RATE + WORKOUTS

FAT BURN

The **FAT BURN** workout is designed to maintain a user's heart rate at 65 percent of the theoretical maximum[†]. Throughout the workout, the user wears a Polar heart rate chest strap or grips the Lifepulse system sensors. If the user is not wearing a chest strap or grasping the sensors, the **WORKOUT PROFILE** window displays a heart shape, and the display prompts the user to grip the sensors. The console continuously monitors and displays the heart rate, adjusting the intensity level of the Cross-Trainer to reach and maintain the target*. This workout uses the body's fat stores and carbohydrates as sources of fuel. A high percentage of total expended energy is from fat.

CARDIO

The **CARDIO** workout is virtually identical to **FAT BURN**; however the target heart rate* is calculated at 80 percent of the theoretical maximum and more calories from fat are burned in this workout. The user wears a chest strap or grips the Lifepulse system sensors. The higher target promotes cardiovascular improvement by placing a heavier workload on the heart muscle.

HEART RATE HILL™

This program combines the standard **HILL** workout profile with the concept of Heart Rate Zone Training. The default target heart rate* is calculated as 80 percent of the theoretical maximum[†] (HRmax), but the user can adjust the target rate during the workout setup. All hills and valleys are percentages of HRmax. The workout consists of three hills that target three heart rate goals: The first hill brings the heart rate to 70 percent of HRmax. The second hill increases the rate to 75 percent of HRmax. The third hill matches the Target Heart Rate bringing the heart rate to 80 percent of HRmax. The valley always is defined as 65 percent of HRmax.

After a standard three-minute warm-up, the workout progresses toward the first hill and heart rate goal. Once the user reaches 70 percent of HRmax, the hill continues for one minute. When the minute expires, the level decreases into a valley. Once the user's heart rate falls to 65 percent of HRmax, the valley continues for one minute. Then the next hill begins with its corresponding heart rate goal. After the user completes the third hill/valley pair, the program returns to the first hill and repeats the cycle as long as the duration allows. At the end of the duration, the workout goes into a cool down phase. If the heart rate goes above the theoretical maximum for more than 45 seconds, the cross-trainer automatically goes into pause mode. The program does not proceed to a new heart rate goal until the user reaches the current goal. The user must wear a heart rate chest strap or grip the Lifepulse sensors throughout the workout.

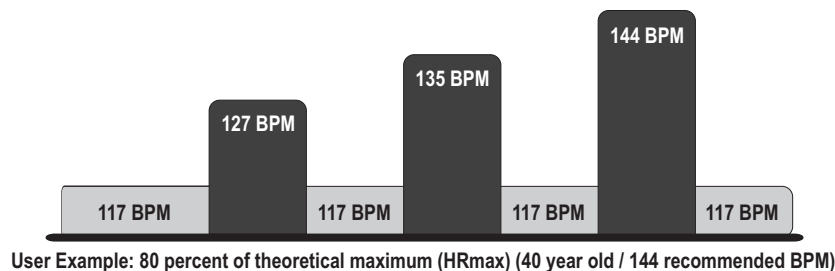
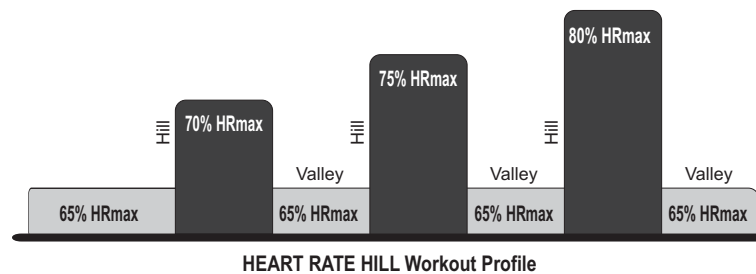

HEART RATE INTERVAL

This program also combines the standard **HILL** workout profile with the concept of Heart Rate Zone Training. The default target heart rate* is calculated as 80 percent of the theoretical maximum† (HRmax), but the user can adjust the target rate during the workout setup. The workout alternates between a hill, which brings the heart rate up to the target rate of 80 percent of HRmax, and a valley, which brings the heart rate down to 65 percent of HRmax. After a standard three-minute warm-up, the workout progresses toward the first hill and heart rate goal. Once the goal is reached, the hill continues for three minutes. Then the level decreases into a valley. Once the 65 percent of HRmax goal is reached, the valley continues for three minutes, after which the next hill begins. The user's fitness level determines the number of hills and valleys encountered within the duration. At the end of the duration, the workout goes into a cool down phase. If the heart rate goes above the theoretical maximum† for more than 45 seconds, the cross-trainer automatically goes into pause mode. The program does not proceed to a new heart rate goal until the user reaches the current goal. The user must wear a heart rate chest strap or grip the Lifepulse sensors throughout the workout.

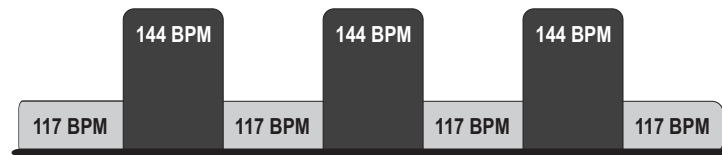
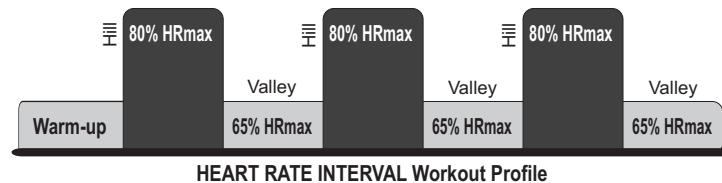

User Example: 80 percent of theoretical maximum (HRmax) (40 year old / 144 recommended BPM)

EXTREME HEART RATE

This intense, varied workout is designed to help more experienced users break through fitness improvement plateaus. The workout alternates between two target heart rates* as quickly as possible. The effect is similar to that of running sprints. The user must wear a chest strap or grip the Lifepulse™ sensors throughout the workout.

When setting up the workout, the user enters a target heart rate. After a standard three-minute warm-up, the intensity increases, until the user reaches the target heart rate goal of 85 percent of the theoretical maximum† (HRmax). That target rate is maintained for a stabilizing period. Then, the intensity decreases. When the heart rate falls to the 65 percent of HRmax goal, it is maintained there for a stabilizing period. The program repeats the alternating of intensity levels, continuing this pattern throughout the duration. The program does not proceed to a new heart rate goal until the user reaches the current goal.

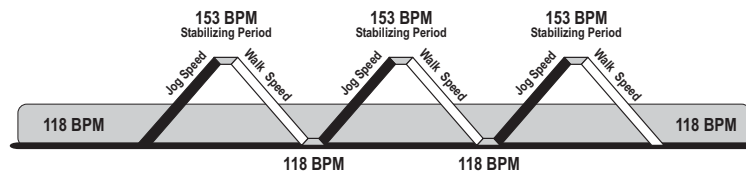
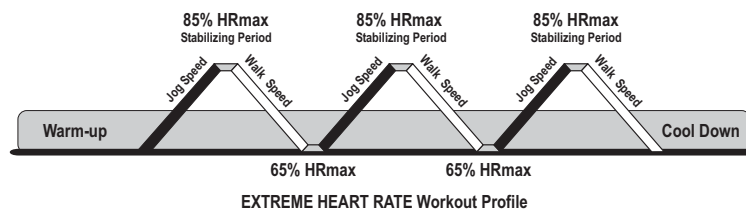

User Example 85 percent of theoretical maximum (HRmax) (40 year old / 153 recommended BPM)

† Defined by the American College of Sports Medicine's "Guidelines for Exercise Testing and Prescription" as equal to 220 minus an individual's age.

* Target Heart Rate (THR) is a percentage of the theoretical maximum (HRmax). A 40-year-old user's recommended THR for the **HEART RATE HILL** and **HEART RATE INTERVAL** workouts is 144, or 80 percent of the maximum; so the equation would be $(220-40) \cdot 80 = 144$.

HILL + WORKOUTS

HILL PLUS

The Life Fitness patented **HILL PLUS** workouts give even more ways to vary interval training. Based on the same principles as the HILL workout, Hill Plus workouts are customized to resemble different locations/training scenarios to add variety and challenge to Hill workouts

1) AROUND THE WORLD

An interval-training workout in which the hills resemble scenes of various geographical areas.

2) CASCADES

A two-peak workout in which intensity levels gradually increase and decrease.

3) FOOTHILLS

A rolling hill workout with low intensity levels.

5) KILIMANJARO

A Hill workout in which the intensity levels gradually incline toward one ultimate peak and then gradually decline.

ADVANCED WORKOUTS

FIT TEST

The Life Fitness Cross-Trainer Fit Test program is another exclusive feature of this versatile cross-trainer. The Fit Test workout calculates cardiovascular fitness and can be used to monitor improvements in endurance every four to six weeks. The user must grasp the hand sensors when prompted or wear a heart rate chest strap, as the test score calculation is based on a heart rate reading. The workout duration will be five minutes at the chosen resistance level. Immediately afterward, the console will take the user's heart rate reading, calculate a fitness score, and display the score in the Message Area.

The Fit Test is considered to be a submax VO₂ (volume of oxygen) test. It gauges how well the heart supplies oxygenated blood to the exercising muscles, and how efficiently those muscles receive oxygen from the blood. Physicians and exercise physiologists generally regard this test as a good measure of aerobic capacity.

To set up the Fit Test:

- Begin pedaling.
- Choose ADVANCED, FIT TEST.
- Go through the setup screens for the Fit Test, including weight, age and gender. Press ENTER after each selection to record the entry. (Gender does not require selecting ENTER afterwards.)
- The setup screen for a workout level will appear. (ENTER LEVEL). Consult the following recommended fit test level chart for an appropriate effort level based on age, gender and activity level. Press ENTER after the selection.
- As the test continues, a message will prompt the user to maintain a pedaling rate between 50-60 rpm (equivalent to 4.2-5.5 mph). The user must maintain this rate throughout the 5-minute test duration. After 16 seconds, if 50-60 rpm is not maintained, the fit test will automatically terminate.

After the five-minute FIT TEST is completed, a FIT TEST score will be displayed.

FIT TEST PROGRAM SUGGESTED EXERTION LEVELS

	Inactive	Active	Very Active
Cross-Trainer Fit Test Level	L2-4 men	L3-10 men	L7-15 men
	L1-2 women	L2-5 women	L3-10 women

Suggested exertion levels should be used as a guideline for setting up the Fit Test program. The goal is to elevate the user's heart rate to a level that is between 60%-85% of their theoretical maximum heart rate.

Within each suggested range, these additional guidelines can be used:

Lower Half of Range	Upper Half of Range
higher age	lower age
lower weight	higher weight*
shorter	taller

* In cases of excessive weight, use lower half of range.

The computer will not accept:

- heart rates less than 52 or greater than 200 beats per minute
- body weights less than 75 pounds (34 kg) or greater than 400 pounds (181 kg)
- ages below 10 or over 99 years
- data input that exceeds human potential

If an error is made when entering any Fit Test data, correct it by pressing CLEAR, inputting the correct information, and pressing ENTER.

It is important to take the Fit Test under similar circumstances each time. Heart rate is dependent on many factors, including:

- amount of sleep the previous night (at least seven hours is recommended)
- time of day
- time of last meal (two to four hours after the last meal is recommended)
- time since last beverage containing caffeine or alcohol, or cigarette (at least four hours is recommended)
- time since last exercised (at least six hours is recommended)

For the most accurate Fit Test results, perform the Fit Test on three consecutive days and average the three scores.

NOTE: To receive a proper Fit Test score, the work done must be within a training heart rate zone that is 60 percent to 85 percent of the theoretical maximum heart rate (HRmax). This rate is defined by the American College of Sports Medicine's "Guidelines for Exercise Testing and Prescription" as equal to 220 minus an individual's age.

The tables below list fit test results.

RELATIVE FITNESS CLASSIFICATION FOR MEN

Men	Estimated VO ₂ Max (ml O ₂ /kg/min) Per Age Category				
Rating	20-29	30-39	40-49	50-59	60+
Elite	55+	52+	51+	47+	43+
Excellent	53-54	50-51	49-50	45-46	41-42
Very Good	50-52	48-49	46-48	43-44	39-40
Above Average	45-49	43-47	42-45	39-42	35-38
Average	40-44	38-42	37-41	34-38	31-34
Below Average	38-39	36-37	34-36	32-33	29-30
Low	35-37	34-35	31-33	29-31	26-28
Very Low	<35	<34	<32	<29	<26

RELATIVE FITNESS CLASSIFICATION FOR WOMEN

Women	Estimated VO2 Max (ml O ₂ /kg/min) Per Age Category				
Rating	20-29	30-39	40-49	50-59	60+
Elite	47+	44+	42+	37+	35+
Excellent	45-46	42-43	40-41	35-36	33-34
Very Good	43-44	40-41	38-39	33-34	31-32
Above Average	38-42	36-39	34-37	30-32	27-30
Average	33-37	31-35	30-33	26-29	24-26
Below Average	31-32	29-30	28-29	24-25	22-23
Low	28-30	27-28	25-27	22-23	20-21
Very Low	<28	<27	<25	<22	<20

Life Fitness developed this rating scale based on VO₂ max percentile distributions referenced in *American College of Sports Medicine's "Guidelines for Exercise Testing and Prescription"* (7th Ed. 2006) which were obtained from the data collected by the Cooper Institute Aerobics Center Longitudinal Study, 1970-2002. It is designed to provide a qualitative description of a user's VO₂ max estimation; and a means of guiding assessment and tracking improvement.

CREATE YOUR OWN

CREATE YOUR OWN workouts enable the user to design personalized workouts based on **LEVEL INTERVAL** or on **HEART RATE INTERVAL**. **CREATE YOUR OWN WORKOUTS** may be disabled through the manager's configuration screen (See Section 5.2, *Configuration Menu, Manager's Configuration 2, Create Your Own Manager Configuration*, for details). Users cannot name and save their workout.

CUSTOM WORKOUTS

These training programs are preset custom workouts created by the facility training professional. The workouts may be **LEVEL INTERVAL** or **HEART RATE INTERVAL** workouts created for specific results. Each Custom Workout can have up to four different setups. The training professional can create customized workout names for each setup. Consult the facility training professional for details on individual Custom Workouts.

WORKOUT LANDSCAPE™ PERSPECTIVES

Workout Landscapes provide users with three additional ways to visualize progress through a workout.

1) 400-METER TRACK (DEFAULT)

The 400-Meter Track appears whenever a workout begins. This Landscape shows the current workout as an indicator line that traces a path around a 400-meter track, marking off 100-meter intervals. Every time the user travels 400 meters, taking the indicator line all the way around the track, the lap counter in the lower left of the profile screen increases by one and the indicator line starts over at the beginning of the track. To return to the 400-Meter Track after selecting a Workout Landscape, touch the 400-Meter Track icon in the top left of the profile screen.



2) CLASSIC PROFILE

Switch to the Classic Profile by touching the Classic Profile icon in the top left of the profile screen. This view shows the level of intensity in a workout-in-progress as proportional columns. The height of the column furthest to the left is proportional to the current level of intensity.

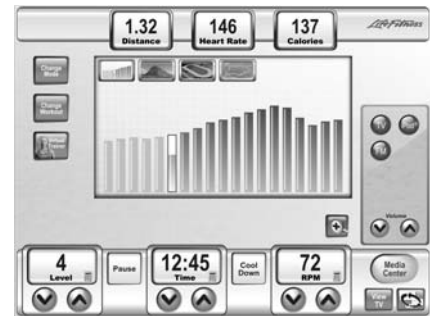

3) MOUNTAIN

Switch to the Mountain Landscape by touching the Mountain icon in the top left of the profile screen. This Landscape shows the current workout as an indicator line that traces a path up the face of a 2,000 foot / 610 meter high mountain. Every time the user climbs the equivalent of 2,000 feet / 610 meters, taking the indicator line to the top of the mountain, the mountain counter in the lower left of the profile screen increases by one and the indicator line starts over at the base of the mountain.



4) 5K NATURE TRAIL

Switch to the 5K Nature Trail Landscape by touching the Trail icon in the top left of the profile screen. This Landscape shows the current workout as an indicator line that traces a path around a 5-kilometer trail, marking off 1-kilometer intervals. Every time the user travels 5 kilometers, taking the indicator line all the way around the trail, the lap counter in the lower left of the profile screen increases by one and the indicator line starts over at the beginning of the trail.



4.4 MAXIMIZING WORKOUTS ON A LIFE FITNESS CROSS-TRAINER

SELECTING A LEVEL

The Life Fitness Cross-Trainer provides a selection of 25 intensity levels. Each level represents a range of resistance percentages. Selecting a low intensity level at first is recommended. As physical conditioning improves, the levels can increase.

COOL DOWN

Life Fitness' unique cool down protocol automatically customizes every cool down based on each user's workout performance. Workout performance factors, such level, duration, and heart rate, determine the duration and intensity of the cool-down.

4.5 ADDITIONAL FEATURES

AUDIO CUES

Audio Cues alert users to stages of their workout. Note that audio events are disabled while the TV or FM radio features are in operation. The manager may also disable Audio Cues through the Manager's Configuration screen (See Section 5.2, *Manager's Configuration 2, Audio Cues*, for details).

- Startup Sound: Plays when a workout begins, such as when the Quick Start key is pushed or the workout timer starts running on any other workout.
- Pause Sound: Plays when a workout is paused and when a paused workout resumes.
- Finish Sound: Plays when a workout enters the cool down phase, when a workout is complete, and when the Workout Summary is displayed.
- Heartbeat Sound: Plays to prompt the user to grasp the contact heart rate sensors.

iPod COMPATIBILITY

This compatibility makes it possible for iPod users to plug in and charge their iPods and iPod nanos, control their iPod playlists from the console and watch iPod-delivered video on the equipment's large LCD screen. Users can plug their headphones directly into the equipment console while safely storing their player in the iPod holding tray.

VIRTUAL TRAINER

Created for beginners as well as the frequent fitness equipment user, the Virtual Trainer takes the intimidation out of beginning a new workout and provides ongoing encouragement. With the push of a button, a male or female face appears on the integrated LCD screen and advises the user on every aspect of the workout, from describing workout programs and general product usage to updates on workout statistics including distance, calories and time.

USB CONNECTIVITY

Users can create and save workouts and personal settings, such as weight, goals and speed on any USB stick so that they don't have to enter the data again the next time they work out. This feature also enables users to track workout performance by allowing them to save their workout results to the USB stick at the end of the workout.

ZOOM FEATURE

This feature enlarges the speed, level and time displays for easier viewing of data.

MEDIA CENTER

Allows the user to access TV controls when the TV is viewed in full screen. The media center will appear over the TV picture. It will automatically close after 10 seconds of idle time.

5 SYSTEM OPTIONS MENU

5.1 USING THE SYSTEM OPTIONS MENU

Fitness club managers and other authorized personnel can use the Systems Options feature to change default settings, or to enable or disable certain programs or displays on the Engage console, and to run systems checks. To enter the Systems Options, press SELECT WORKOUT. Then touch the Life Fitness logo in the upper right hand corner of the screen three consecutive times.

SYSTEM OPTIONS OVERVIEW

SYSTEM TEST

Allows technicians to run systems diagnostics. **NOTE:** These tests should only be used by (or with the explicit instruction of) a trained Life Fitness service technician.

SYSTEM TEST MENU 1

- System Comm Test
- System Diagnostics
- Key Pad Test
- iPod Test
- Heart Rate Test

SYSTEM TEST MENU 2

- External Serial EE Test
- CSafe Network Test/Status
- CSafe Loopback Test

INFORMATION

Allows authorized personnel to access statistics on machine usage (Statistics and Usage Log). All other information is designed for use by trained Life Fitness service technicians.

Statistics	Date & Time Information
Software Versions	System Errors
Maintenance Information	
Usage Log	

CONFIGURATION

Allows access to all of the configurable settings of the unit. Configurations which should only be changed by qualified technicians are password protected.

Manager	Create Your Own
Manufacturer (password protected)	Export / Import Settings
TV	Clock

MAINTENANCE

Allows service technicians to submit part replacements. Only for use by qualified service technicians.

- Replacing Console

5.2 CONFIGURATION MENU

MANAGER

Allows the manager to set unit defaults, configure workout duration, set stand by, and program custom messages. Choosing Manager accesses **Manager's Configuration 1**. The forward button on the bottom right of the screen opens **Manager's Configuration 2**.

Manager's Configuration 1 accesses defaults for Language, Units (English or Metric), Workout Duration Configuration, and Stand By Configuration.

Manager's Configuration 2 accesses defaults for Custom Message, Create Your Own, Program Timeout, Fit Test, Marathon Mode, System Beeps, Pause Time, Telemetry, Virtual Trainer, Network, and Audio Cues.

TO SET DEFAULTS

Select appropriate radio buttons to select toggle settings. Use the arrow keys to modify variable default values. Select DEFAULTS to return all values to original factory settings. See chart 5.3 for an overview of adjustable configurations and factory defaults of the Life Fitness Cross-Trainer.

1) MANAGERS CONFIGURATION 1

LANGUAGE (DEFAULT: ENGLISH)

To enable the Language option, select the Language button to enter the Language Setup screen. Toggle the mode from DISABLED to ENABLED. The following can be configured:

1. Default language.
2. Which of 13 languages are available to the user.
3. What order the language flags appear on the Home Screen.
4. Which flag will appear to represent those languages that may have multiple options.

The available language flags appear on the Home Screen. The user must select a language change before beginning a workout. If more than six languages are configured available, a More Flags button will appear which will open a language selection screen for the user. Upon selecting a language flag, the language will immediately become active and the selection screen will close.

The following languages are available:

English, German, French, Italian, Japanese, Dutch, Spanish, Portuguese, Korean, Russian, Turkish, Traditional Chinese, and Simplified Chinese.

UNITS (DEFAULT: ENGLISH)

Toggle the default units displayed between ENGLISH and METRIC. Choose "User Selectable" to allow users to choose desired units on-screen during a workout.

WORKOUT DURATION CONFIGURATION (DEFAULT: 60 MINUTES)

Workout Duration Configuration: Allows the manager to set a maximum workout limit. The default Max Workout Duration is 60 minutes. The time can be modified using the up or down arrow keys.

STANDBY CONFIGURATION (DEFAULT: ENABLED)

Inactivity Timer: Under Stand By Configuration choose INACTIVITY TIMER, then select ENABLED. Set the desired amount of time of inactivity before the system automatically turns the LCD screen backlight off. The LCD screen will illuminate the next time activity is detected. To turn off the Inactivity Timer, choose DISABLED.

2) MANAGERS CONFIGURATION 2

CUSTOM MESSAGE (DEFAULT: ENABLED)

This configuration allows for a custom message to be displayed across the Home Screen.

Creating/Changing a Custom Message — Upon entering the Custom Message Setup screen, a message can be entered using the on-screen keyboard. Use the Shift button to input special characters and capital letters. The message will scroll across the top of the screen as the message is being input, giving real-time feedback.

Accepting a Custom Message — To accept the Custom Message, simply select the Main Menu button.

Erasing a Custom Message — To erase a Custom Message, enter the Custom Message Setup screen. Select the Clear Message button and then select Main Menu.

CREATE YOUR OWN (DEFAULT: ENABLED)

The manager can enable or disable the Create Your Own workout feature.

PROGRAM TIMEOUT (DEFAULT: 60 SECONDS)

Sets the amount of time the user can go without touching the Touchscreen while setting up their workout, before the console resets back to the Home Screen. Program Timeout can be set from 20 to 255 seconds.

FIT TEST (DEFAULT: ENABLED)

Choose OFF to disable the Life Fitness Fit Test.

MARATHON MODE (DEFAULT: DISABLED)

Marathon Mode has no preset or settable goal. It allows the user to workout indefinitely. If enabled, a workout in Marathon Mode ends only if the user chooses to end it or a stop system is activated.

SYSTEM BEEPS (DEFAULT: ON)

The System Beeps Configuration allows the manager to disable the beeping sound.

PAUSE TIME (DEFAULT: ONE MINUTE)

Managers can adjust the Pause Time from 1 to 99 minutes.

TELEMETRY (DEFAULT: ENABLED)

The telemetry feature makes it possible to use the Polar®-compatible Heart Rate Zone Training exercise chest strap for monitoring the heart rate.

VIRTUAL TRAINER (DEFAULT: ON)

The Virtual Trainer feature makes it possible for a male or female face to appear on the integrated LCD screen and advise the user on every aspect of the workout.

NETWORK (DEFAULT: VIVO)

Managers can select from the following options: Vivo, Other (network), and None.

AUDIO CUES MANAGER CONFIGURATION

The Audio Cues Manager Configuration allows the manager to enable or disable the Audio Cues feature.

3) TV / FM RADIO

Brings up TV / FM Radio configuration screen, which is used to set and customize TV and FM radio reception options.

TV SETUP

Opens the TV Setup screen allowing adjustment of brightness, contrast, saturation, and hue. Also allows choice of TV format and channel setup.

- To Set Up Channels: select Channel Setup; Auto, Start.
Audio Only option: Allows only the TV audio to be heard. TV video is disabled.
- To Delete an Unwanted Channel: Choose Channel Setup; Manual, use the Channel Controls to choose the channel to be deleted, select delete, return the Channel Setup to Auto.
- To Restore a Channel: Choose Channel Setup, Manual; use the Channel Controls to choose the channel to be restored, select Add, return the Channel Setup to Auto.
- To Adjust Picture Setup: Brightness, Contrast, Saturation, and Hue can be adjusted by using the corresponding arrow buttons. To return to the unit defaults, select Default.

Max Volume Setup: Opens the Max Volume controls. (Headphones must be used for this function.) The upper set of arrows adjusts the volume capacity higher or lower, allowing clubs to compensate for average noise levels within. The maximum volume returns to this default after each workout.

The Volume Down, Volume Up arrows control the volume of the unit for the current usage. After each session ends, the unit resets to a mid-range volume corresponding to the maximum volume set up.

TV Format: Opens the TV Format window. Choose the appropriate country, TV format (NTSC-M, PAL-I, PAL-B/G, SECAM-L), and Audio format (M-Korea, B/G FM, D/K1, D/K2, D/K Mono HDEV3, D/K3, B/G NICAM, L NICAM-AM, I NICAM, D/K NICAM, D/K NICAM HDEV2, D/K NICAM HDEV3, BTSC-Stereo) from the provided listings. Select OK to accept the settings.

Frequency Tuning: Opens the Frequency Tuning window. Allows channel scanning through all available frequencies beginning at 45 MHz. Begin a scan by selecting Start. Scroll through found channels using the Channel Up and Down arrow keys on the screen.

Channels can be fine tuned using the arrow keys located below the Frequency Tuning Start button. Use the Channel Up and Down arrow keys to select a channel to fine tune. Press the Fine Tuning arrow keys to adjust the frequency for the best possible picture.

Select OK to accept channels.

TV CHANNEL FAVORITES

Opens the Favorite Channel configuration screen. Up to 9 favorite channels can be stored for quick access during a workout. This feature may be enabled or disabled.

NOTE: Setting channels using the auto channel setup procedure, as instructed in TV SETUP, is recommended before attempting to setup favorite channels.

To Set Up a Favorite Channel: Select (touch) the ENABLE radial button, select the radial button next to the input slot desired, select Enter Name, input the channel name using the keyboard display, select OK to accept the channel name, select the desired channel using the Up or Down ARROW Keys. Continue as desired to set up to 9 favorite channels. Select OK to set the channels to memory.

TV CHANNEL NAME/SORT

Opens the Channel Name / Sort configuration screen. Allows the facility manager to customize the TV channel list order. This feature may be enabled or disabled.

NOTE: Setting channels using the auto channel setup procedure, as instructed in TV SETUP, is recommended before attempting to setup favorite channels.

Validation: The validation checkbox enables or disables viewing of the channel in the list. Select the checkbox to enable the channel. If Channel Name / Sort and Channel Favorites are both enabled, channels not marked as valid (enabled) in Channel Name / Sort will be removed from Channel Favorites.

Channel Swap: To swap channels within the channel listing, select Channel Swap. Select the radio button next to the desired channel. The Channel Swap window will appear showing the channel selected for swapping. Use the Up or Down arrow keys to select the second channel to swap with the previous channel. Select the swap button to preview the channel swap information. Press OK to confirm the channel swap or CANCEL to exit without swapping channels.

PROMO CHANNEL SETUP

Opens the Promo Channel Setup screen. If enabled, one existing input channel can be selected to be a dedicated channel for internal promotional broadcast use. Select the Channel Change button to scroll up or down to the desired channel.

ADVANCED PROMO CHANNEL SETTINGS

When Promo Channel is enabled, the option becomes available to choose how Promo Channel may be configured when viewed in the attract screen.

If "Promo Channel Only" is selected, only the channel selected as the Promo Channel is available for display in the attract screen.

If "Allow User to Change Channel" is selected, users may change the channel displayed in the attract screen using the CHANNEL UP or DOWN arrow keys.

Within this option, the number of minutes before the TV display returns to the Promo Channel is set. Whether or not the unit starts up with the Promo Channel displayed can also be configured.

If "Start with Promo Channel" is not selected, the unit will startup and display the last channel selected by the user.

FM RADIO SETUP

Opens the FM Radio Setup screen allowing FM channel setup. This feature may be enabled or disabled.

To Set Up Channels: Select Channel Setup; Auto, Start.

To Delete an Unwanted Channel: Choose Channel Setup; Manual, use the Channel Controls to choose the channel to be deleted, select delete, return the Channel Setup to Auto.

To Restore a Channel: Choose Channel Setup; Manual, use the Channel Controls to choose the channel to be restored, select Add, return the Channel Setup to Auto.

4) TOUCH SCREEN CONFIGURATION

Follow the instructions on the screen to recalibrate the Touch Screen. If calibration was successful, a prompt will appear along with a 30 second countdown. Touch the screen anywhere to save the calibration data. If calibration was unsuccessful, a "+" will appear in the center of the screen and the calibration will have to be redone. Contact Life Fitness if repeated attempts at calibration were unsuccessful.

5) EXPORT / IMPORT SETTINGS

Brings up the Export / Import Settings screen which is used to import or export manager and manufacturer configurable settings. This can be advantageous when many or all optional features are enabled and configured.

To Import or Export Settings: Insert a USB stick into the USB port. Enter the Import/Export Settings through the Configuration Menu. Select "Import Settings to USB" or "Export Settings To USB". Upon notification, remove the USB stick from the USB port.

NOTE: It is important to turn the unit off before inserting or removing the USB stick.

NOTE: Exported setting information is product specific. Cross-Trainer settings can only be imported into other, same model cross-trainers. Cross-trainer settings cannot be used to update settings of any other product.

NOTE: This method is not recommended for the setup of basic TV or FM channels. See TV Setup or FM Radio Setup to set basic channel configuration.

5.3 CONFIGURATION SETTINGS

MANAGER'S CONFIGURATION 1

SETTING	DEFAULT	DESCRIPTION
LANGUAGE	ENGLISH	The language of the Message Area display. Choices include English, German, French, Italian, Japanese, Dutch, Spanish, Portuguese, Korean, Russian, Turkish, Traditional Chinese and Simplified Chinese.
ENGLISH/METRIC UNITS	ENGLISH	The measurement unit type for weight, distance, and speed.
WORKOUT DURATION	60 MINUTES	This feature enables fitness club managers to set workout duration limits during peak and non-peak hours of club traffic. If the setup is off, no duration limits are set. See the topic Section 5.1, Workout Duration Configuration. The allowed range is 1 to 99 minutes.
STANDBY CONFIGURATION	ENABLED	Inactivity Timer: Enables the LCD screen backlight to be turned off due to inactivity. See Section 5.1, Standby Configuration.

MANAGER'S CONFIGURATION 2

SETTING	DEFAULT	DESCRIPTION
CUSTOM MESSAGE SETUP	ENABLED	See Using the Custom Message Setup in this section.
CREATE YOUR OWN	ENABLED	This feature allows the manager to enable or disable the Create Your Own Workout feature.
PROGRAM TIMEOUT	60 SECONDS	The amount of time the user can go without touching the Touchscreen during workout setup, before the unit returns to the Home Screen. The allowed range is 20 to 255 seconds.
FIT TEST	ENABLED	Enable/Disable Fit Test.
MARATHON MODE	DISABLED	Enable/Disable Marathon Mode.
SYSTEM BEEPS	ON	Enable/Disable System Beeps.
PAUSE TIME	1 (minute)	The amount of time the unit can be inactive before it reverts back to the Home Screen. The allowed range is 1 to 99 minutes.
TELEMETRY	ENABLED	Switching on the telemetry feature makes it possible to use the Polar®-compatible Heart Rate Zone Training exercise chest strap for monitoring the heart rate.
VIRTUAL TRAINER	ON	Enable/Disable the Virtual Trainer feature.
NETWORK	VIVO	Choose from the following three network options: Vivo, Other (network), and None.
AUDIO CUES	ENABLED	Enable/Disable Audio Cues.

5.4 SPECIFICATIONS

LIFE FITNESS 95X ENGAGE CONSOLE SPECIFICATIONS

Console Option:	15" E ³ Integrated LCD™ System with Touch Screen Technology
Resolution:	1024x768
Channel Coverage:	CATV: 1-125
Headphone Jack:	300 milliwatt, 3.5mm Stereo
Broadcast Capabilities:	PAL/SECAM and NTSC require separate tuners. NTSC tuner supports NTSC-Japan, NTSC-HRC, NTSC-M, NTSC-N. NTSC also supports PAL-M and PAL-N which are unique PAL encodings for Argentina, Brazil, Paraguay and Uruguay. PAL/SECAM tuner supports PAL, PAL-M, PAL-N, SECAM-B/G and SECAM-D/K.
Touch Screen:	5-Wire Resistive Touch Screen
Touch Screen Display:	Select Workout, Virtual Trainer, USB Preset Selection, Workout Setup, Workout Progress, Workout Summary Information, Media Center, Language Select, Quick Start, VIVO, Screen Lock/Unlock
Workouts:	Quick Start // Classic: Manual, Random, Hill, Cross-Train Aerobics, Cross-Train Reverse // Heart Rate +: Fat Burn, Cardio, Heart Rate Hill™, Heart Rate Interval™, Extreme Heart Rate™ // Hill +: Around the World, Cascades, Foothills, Kilimanjaro // Advanced Workouts: Fit Test // Create Your Own: Level Interval and Heart Rate Interval // Custom: Level Interval and Heart Rate Interval
Modes:	Aerobics and Reverse modes during all workouts except for Fat Burn, Cardio, Heart Rate Hill, Heart Rate Interval, or Extreme Heart Rate
Levels:	25 (speed independent)
Manager-Defined/ User-Selected Languages:	English, Spanish, Portuguese, Italian, French, German, Dutch, Russian, Chinese (traditional and simplified), Japanese, Turkish, and Korean
Display Readout:	Level, Heart Rate, Pace, Elapsed Time, Time Remaining, Time in Zone, Time of Day, Distance, Distance Climbed, Distance Remaining, Calories, Calories per Hours, Watts, METs
iPod Compatibility:	iPod video capability on LCD screen iPod/iPod nano playlist management and LCD screen iPod/iPod nano power and charging
TV Special Features:	125 available channels, Favorite Channels, Previous Channel Viewed, Channel Renumbering, Secondary Audio Programs (SAP), Promo Channel, Mute

PHYSICAL DIMENSIONS:

95 XE Engage Console

Length:	16.5 inches / 41.9 centimeters
Width:	15.5 inches / 39.4 centimeters
Height:	4.5 inches / 11.4 centimeters
Weight:	10.75 pounds / 4.9 kilograms

SHIPPING DIMENSIONS:

95 XE Engage Console

Length:	20 inches / 50.8 centimeters
Width:	18.5 inches / 47 centimeters
Height:	7.625 inches / 19.37 centimeters
Weight:	13.6 pounds / 6.2 kilograms

5.5 WARRANTY INFORMATION

WARRANTY COVERAGE 95 XE ENGAGE CROSS-TRAINER

WHAT IS COVERED:

This *Life Fitness* commercial exercise equipment ("Product") is warranted to be free of all defects in material and workmanship.

WHO IS COVERED:

The original purchaser or any person receiving the Product as a gift from the original purchaser.

HOW LONG IS IT COVERED:

All coverage is provided by specific Product according to the guidelines listed on the chart accompanying this warranty card.

WHO PAYS TRANSPORTATION & INSURANCE FOR SERVICE:

If the Product or any covered part must be returned to a service facility for repairs, **We, Life Fitness**, will pay all transportation and insurance charges for the first year. **You** are responsible for transportation and insurance charges during the second and third years (if applicable).

WHAT WE WILL DO TO CORRECT COVERED DEFECTS:

We will ship to you any new or rebuilt replacement part or component, or, at our option, replace the Product. Such replacement parts are warranted for the remaining portion of the original warranty period.

WHAT IS NOT COVERED:

Any failures or damage caused by unauthorized service, misuse, accident, negligence, improper assembly or installation, debris resulting from any construction activities in the Product's environment, rust or corrosion as a result of the Product's location, alterations or modifications without our written authorization or by failure on your part to use, operate and maintain the Product as set out in your Operation Manual ("Manual"). **All terms of this warranty are void if this product is moved beyond the continental borders of the United States of America (excluding Alaska, Hawaii and Canada) and are then subject to the terms provided by that country's local authorized Life Fitness representative.**

WHAT YOU MUST DO:

Retain proof of purchase (*our receipt of the attached registration card assures registration of purchase information but is not required*); **use, operate and maintain** the Product as specified in the Manual; **notify** Customer Support Services of any defect within 10 days after discovery of the defect; if instructed, **return** any defective part for replacement or, if necessary, the entire Product for repair.

OPERATION MANUAL:

It is **VERY IMPORTANT THAT YOU READ THE MANUAL** before operating the Product. Remember to perform the periodic maintenance requirements specified in the Manual to assure proper operation and your continued satisfaction.

WARRANTY REGISTRATION:

Please **COMPLETE and MAIL** the attached registration card **IMMEDIATELY**. Our receipt assures that your name, address and date of purchase are on file as a registered owner of the Product. Failure to return the card will not affect your rights under this warranty. Being a registered owner assures coverage in the event you lose your proof of purchase. In any event, always retain proof of purchase, such as your bill of sale.

HOW TO GET PARTS & SERVICE:

Simply call Customer Support Services at (800) 351-3737 or (847) 451-0036, Monday through Friday from 8:00 a.m. to 6:00 p.m. Central Standard Time, and tell them your name, address and the serial number of your Product. They will tell you how to get a replacement part, or, if necessary, arrange for service where your Product is located or advise you on how and where to ship the Product for service.

Before shipping:

1. **obtain** a Return Authorization Number (**RA#**) from Customer Support Services
2. securely **pack** your Product (*use the original shipping carton, if possible*)
3. **write** the **RA#** on the outside of the carton
4. **insure** the Product, and
5. **include** a letter explaining the defect or problem and a copy of your proof of purchase if you believe the service is covered by warranty

EXCLUSIVE WARRANTY:

THIS LIMITED WARRANTY IS IN LIEU OF ALL OTHER WARRANTIES OF ANY KIND EITHER EXPRESSED OR IMPLIED, INCLUDING BUT NOT LIMITED TO THE IMPLIED WARRANTIES OF MERCHANTABILITY AND FITNESS FOR A PARTICULAR PURPOSE, AND ALL OTHER OBLIGATIONS OR LIABILITIES ON OUR PART. We neither assume nor authorize any person to assure for us any other obligation or liability concerning the sale of this Product. Under no circumstances shall we be liable under this warranty, or otherwise, of any damage to any person or property, including any lost profits or lost savings, for any special, indirect, secondary, incidental or consequential damages of any nature arising out of the use of or inability to use this Product. Some states do not allow the exclusion or limitation of implied warranties or of liability for incidental or consequential damages, so the above limitations or exclusions may not apply to you.

CHANGES IN WARRANTY NOT AUTHORIZED:

No one is authorized to change, modify or extend the terms of this limited warranty.

EFFECT OF STATE LAWS:

This warranty gives you specific legal rights and you may have other rights which vary from state to state.

OUR PLEDGE TO YOU:

Our Products are designed and manufactured to the highest standards.

We want you completely satisfied with our Products and will do everything possible under the terms of this warranty to keep you secure in knowing you have bought the best!

Model	2 Years	1 Year
95X	Mechanical and Electrical components	Labor

**NOTE - Once any commercial product is placed in a private residence (home), it automatically becomes covered under that product category's consumer warranty. Warranty coverage begins at the original date of sale.*



M051-00K70-A035

Life Fitness World Headquarters
5100 North River Road
Schiller Park, IL 60176 USA