

ENDURANCE®

B2.5^R
B2.5^U

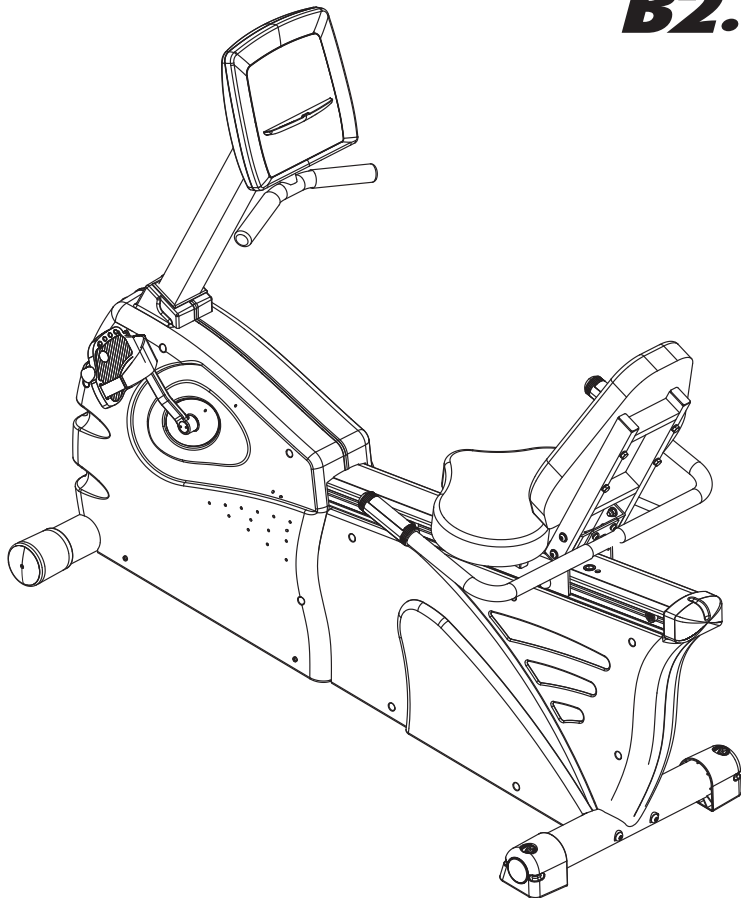

Endurance®
B2.5R Recumbent bike & B2.5U bike

User Manual

SAFETY TIPS	1
MOVING	3
LEVELING	4
SEAT ADJUSTMENTS	5
CONSOLE	6
BUTTONS	7
THE PROGRAMS	8
MANUAL	9
ALL PROGRAMS	11
CARDIO	13
HILLS	14
INTERVAL	15
FAT BURN	16
RANDOM	17
TARGET HEART RATE ZONE	18
LIMITED HOME USE WARRANTY	20
LIMITED LIGHT COMMERCIAL WARRANTY	21
DEVELOPING A FITNESS PROGRAM	22
LIMITED LIGHT COMMERCIAL WARRANTY (continued)	23
FLEXIBILITY	24
EXERCISE GUIDELINES	28
ACHIEVING YOUR FITNESS GOALS	29
SAMPLE GOALS	30
DIARY	31

SAFETY TIPS

IMPORTANT SAFETY INSTRUCTIONS SAVE THESE INSTRUCTIONS

When using an electrical product, basic precautions should always be followed, including the following: Read all instructions before using this exercise product. Your ENDUEANCE RECUMBENT BIKE & BIKE is self-generating (requiring no external power source) and in this mode must be pedaled to power-up the console. Alternatively, the RECUMBENT BIKE & BIKE can instead be plugged into an outlet using the included power supply.

WARNING!

To reduce the risk of burns, fire, electrical shock or injury to persons:

- Use this exercise product for its intended use as described in this Owner's Guide. Do not use attachments not recommended by the manufacturer.
- Never drop or insert any object into any opening.
- Do not remove the RECUMBENT BIKE & BIKE side covers. Only an authorized ENDUEANCE retailer should perform Service.
- Never operate this RECUMBENT BIKE & BIKE if it has a damaged cord or plug, if it is not working properly, if it has been damaged, or immersed in water. Return the RECUMBENT BIKE & BIKE to a retailer for examination and repair.
- Do not use outdoors.

CHILDREN

- Keep children off your ENDUEANCE Products at all times.
- When the ENDUEANCE Products is in use, young children and pets should be kept at least 10 feet away.

OTHER SAFETY TIPS FOR YOUR ENDURANCE RECUMBENT BIKE & BIKE

CAUTION!

If you experience chest pains, nausea, dizziness or shortness of breath, stop exercising immediately and consult your physician before continuing.

- Do not wear clothing that might catch on any part of the RECUMBENT BIKE & BIKE.
- Read this Owner's Guide before operating this RECUMBENT BIKE & BIKE.

CLEANING

- Clean with soap and slightly damp cloth only; never use solvents.

MOVING

To move the ENDUEANCE RECUMBENT BIKE & BIKE, firmly grasp the rear foot assembly, carefully lift and roll on the transport wheels.

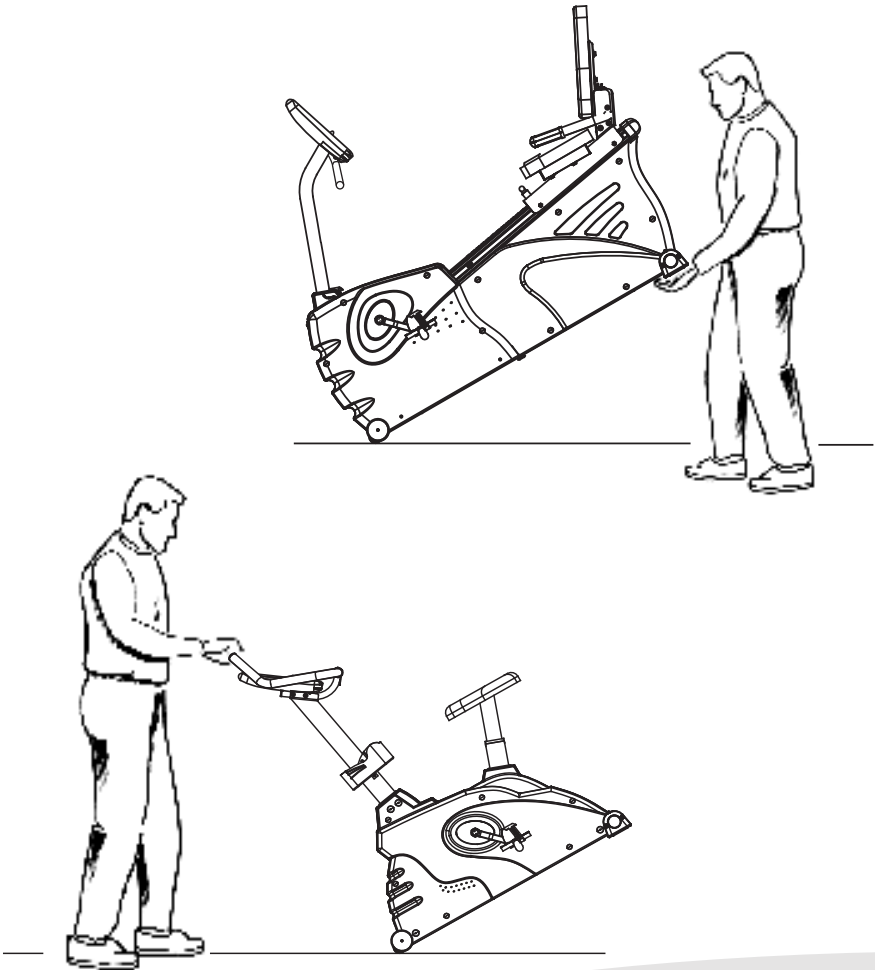

Caution: Our RECUMBENT BIKE & BIKE are wellbuilt and heavy. Take caution and use additional help if necessary.

ENDU

LEVELING

The RECUMBENT BIKE should be level for optimum use. If your RECUMBENT BIKE wobbles when you have placed it where you intend to use it, raise or lower one or both of the adjustable levelers located on the bottom of the rear foot support. Once you have leveled the RECUMBENT BIKE, lock the levelers in place by tightening the wing nuts against the rear foot support.

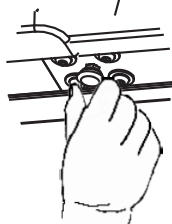
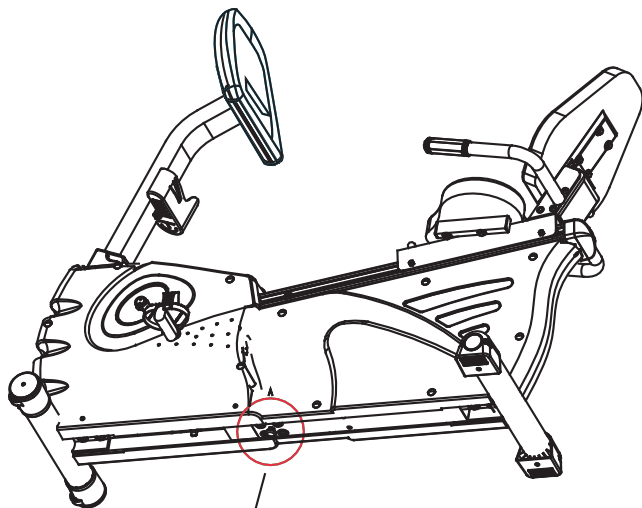

as well as the one located in the middle frame

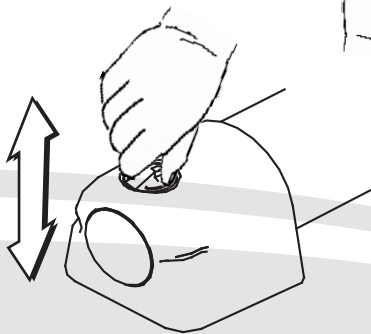

SEAT ADJUSTMENTS

SEAT POSITIONING

The seat is at the proper position when your knee is slightly bent when the pedal is in the furthest position.

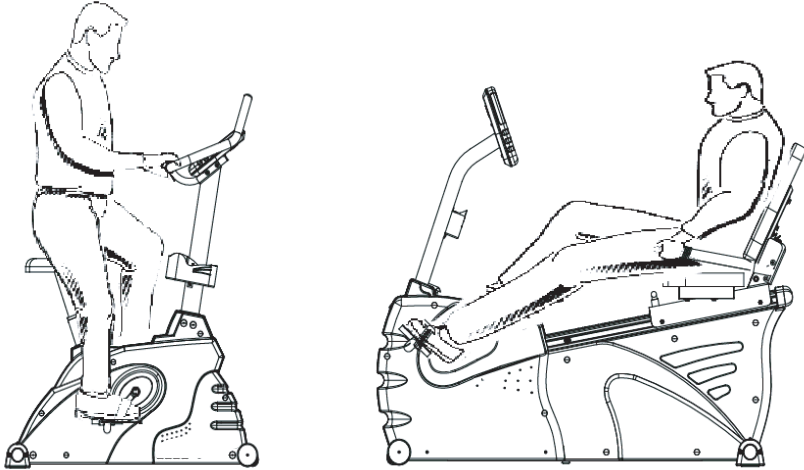

SEAT ADJUSTMENT

Grasp the Seat Adjustment Knob, located at the base of the seat post. Pull out then raise or lower the seat post to the desired height. Release the knob and allow the seat post to lock into position.

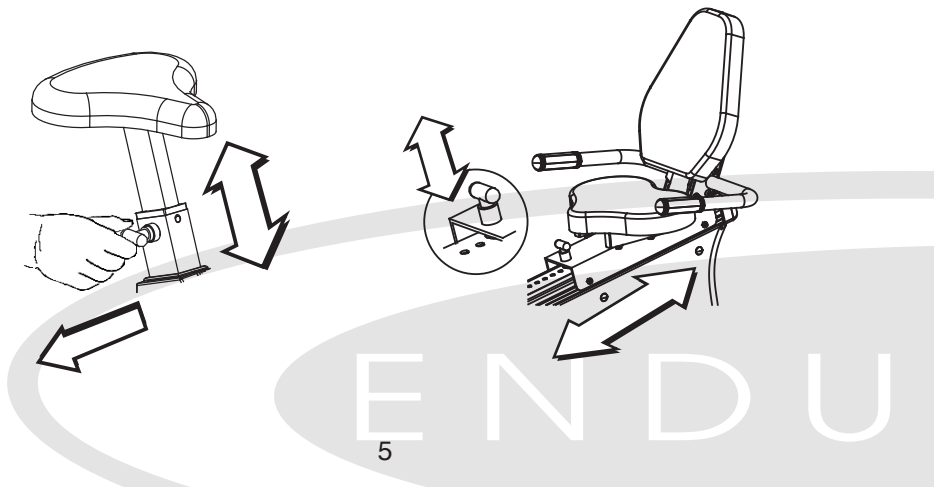



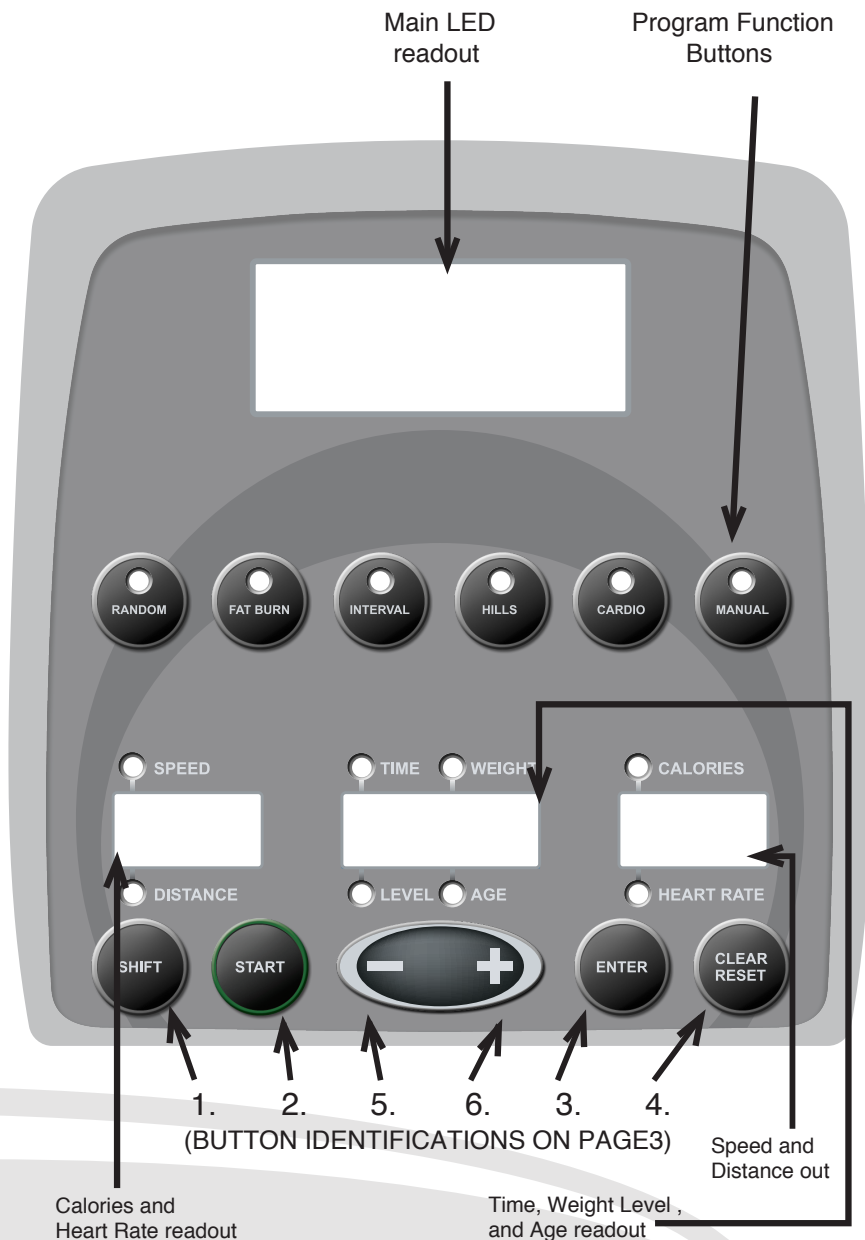



CONSOLE



BUTTONS



Program Function Buttons

1.  Automatically shifts display information every 8 seconds, or stays fixed on the information.
2.  Start the program
3.  Confirm Button
4.  Pauses program, or hold for 3 seconds to CLEAR all information to RESET.
5. 
 -  Decrease the value of program / Select the program
 -  Increase the value of program / Select the program

THE PROGRAMS

The RECUMBENT BIKE & BIKE motion exercise machine is the result of combining the vertical motion of a stair climber and the striding motion of a RECUMBENT BIKE & BIKE. The machine generated RECUMBENT BIKE & BIKE shape is designed to move in both a forward or reverse motion and when combined with the upper body work out supported by the moving handles, train all the body's major muscle groups: Gluteals, Hamstrings, Quadriceps, Calves, Lats, Chest, Deltoids, Biceps and Triceps. The low impact of the RECUMBENT BIKE & BIKE motion provides a cardiovascular workout for everyone from beginners to serious athletes. When compared to other cardio exercises, the RECUMBENT BIKE & BIKE trainer's unique motion requires a higher level of oxygen consumption that results in a more intense workout with the same amount of effort typically required on other cardio equipment.

The main exercise programs are designed for two reasons; get you moving quickly with the least amount of set up, and also to guide you through a number of different and motivating routines that maximizes your workout.



Turn the power on, all the lights will go on for one second. The Main Readout will display the programs sequence: Manual, Cardio, Hills, Interval, Fat Burn, Random, HR Fat Burn, HR Cardio, HR Interval, HR Hills.

1. Press the "Start" button or move the pedals, this will start the Manual program.

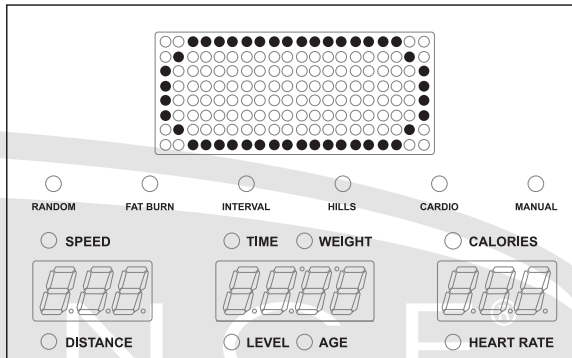

During any of the programs, you can use the  buttons to adjust the Level of resistance, at any time.



2. MANUAL Program: The fastest and simplest way to get started. Just get on the machine, input the basic information and start moving.

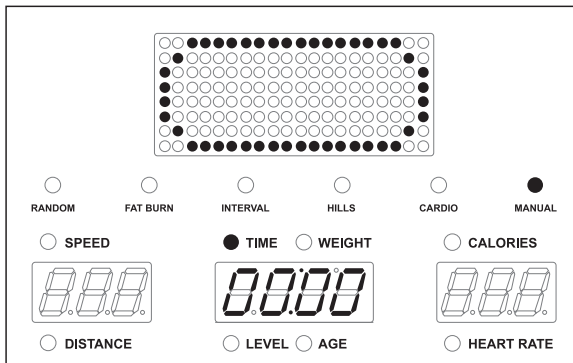

A. Press the "  " button (the MANUAL light will go on, and the Main Readout will display an "oval" graphic). Set up the Time, using the "  " button.



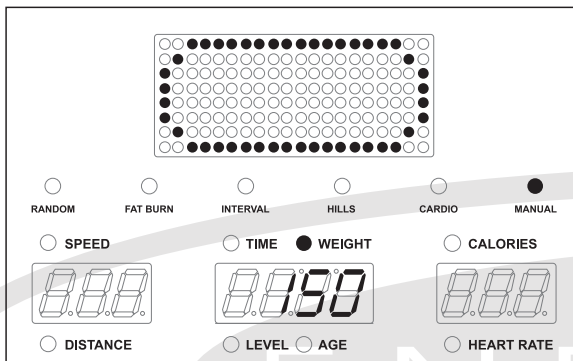

B. Press the "  " button, until the WEIGHT light goes on. The Weight Screen will display 150(flashing), use the "  " button to adjust.

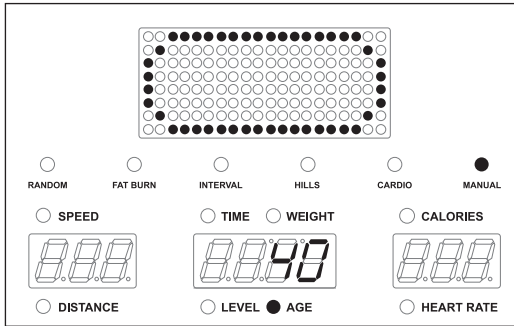

MANUAL

C. Press the "  " button, until the AGE light goes on. The Age Screen will display 40 (flashing), use the "  " button to adjust.



D. Press the "  " button, until the Main Readout scrolls "PRESS START"

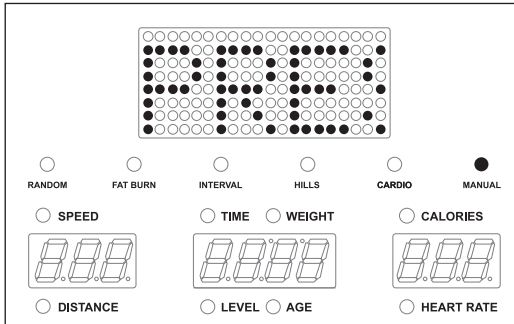

E. Press the "  " button, to start the program.

The oval track distance equals .25 miles

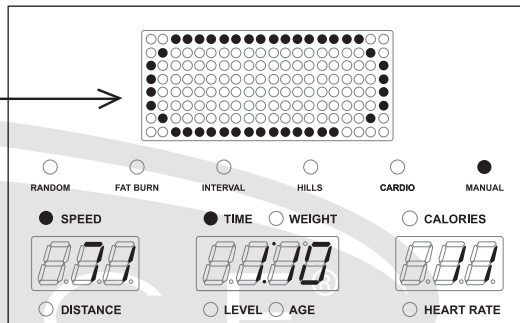

ALL PROGRAMS

A. During all programs, you can adjust the resistance level by using the

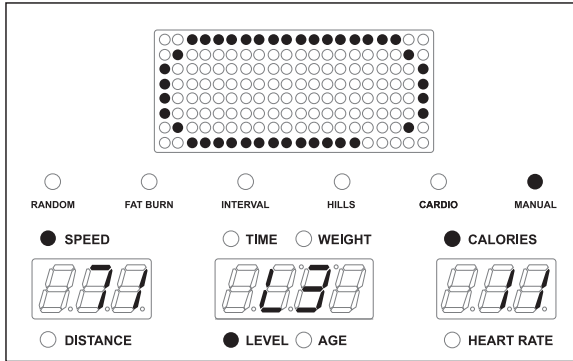

B. If you stop pushing the petals for 10 seconds or press the "  " button the Main Readout will scroll "PAUSE". Then will start a 10 minute count down. If there is no motion during these 10 minutes, the program will reset.

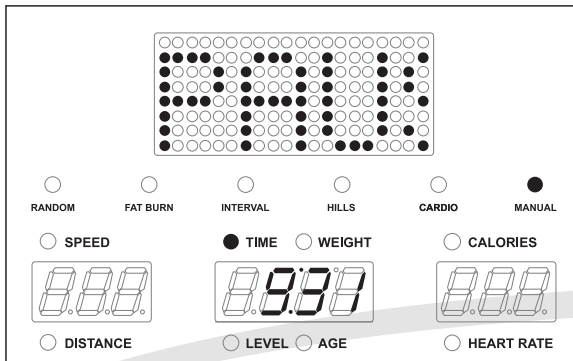

C. There will be three beeps at the conclusion of the pre-set time.

ALL PROGRAMS

D. At the end of the program:

The Main Readout will scroll "COOL DOWN", twice.

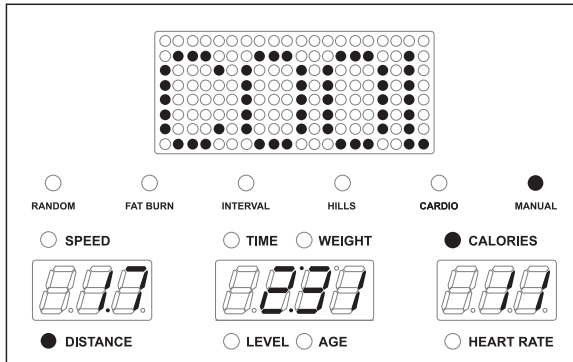

E. After the display of "COOL DOWN", the Main Readout will go back to the oval track.

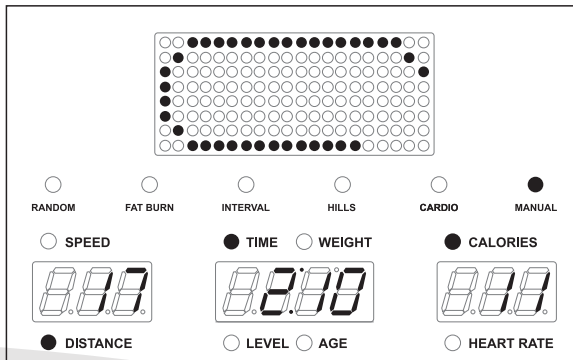

F. After the count down, the Main Readout will display "END".

3. CARDIO program:

The gradual increasing and decreasing of the resistance provides a challenging workout along with maximizing cardiovascular benefits. The program is designed to keep your heart rate at 80% of your calculated maximum heart rate.

A. Press "  " button (" CARDIO " light will go on).

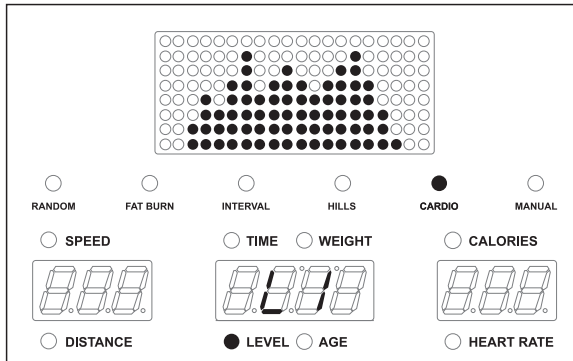

B. Setup the "LEVEL"

*Setup the same way as in the Manual program. (on pages 8 and 9).

Press " ENTER " .

C. Setup the "TIME " , * , Press " ENTER " .

D. Setup the " WEIGHT " , * , Press " ENTER " .

E. Setup the " AGE " , * , Press " ENTER " .

F. The Main Readout will scroll "PRESS START".

Press "  " button, to start the program.

G. You can still adjust the level with the "  " button.

4.HILLS program:

Like walking or jogging up a hill, the stepped increase of the resistance provides a challenging workout that continually builds resistance and heart rate during the length of the program. Similar to sporting activities such as basketball and soccer.

A.Press "  " button (" HILLS " light will go on).

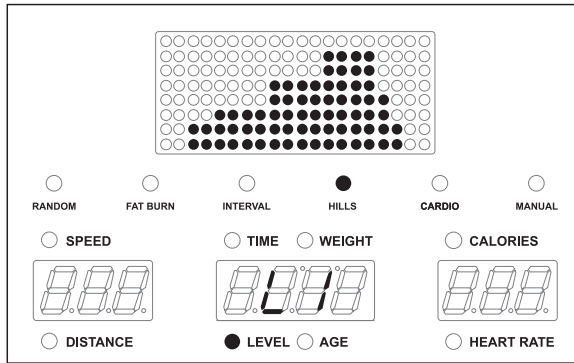

B.Setup the "LEVEL"

*Setup the same way as in the Manual program. (on pages 8 and 9).

Press " ENTER " .

C.Setup the "TIME " , * , Press " ENTER " .

D.Setup the " WEIGHT " , * , Press " ENTER " .

E.Setup the " AGE " , * , Press " ENTER " .

F.The Main Readout will scroll "PRESS START".

Press "  " button, to start the program.

G.You can still adjust the level with the "  " button.

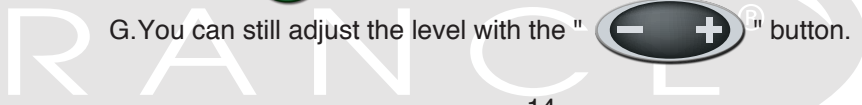

INTERVAL

5.INTERVAL program:

This program varies the intensity of the workout between low and high resistance to quickly raise and lower the heart rate in 2 minute intervals, similar to endurance type training. The upper and lower resistance level the interval.

A.Press "  " button (" INTERVAL " light will go on).

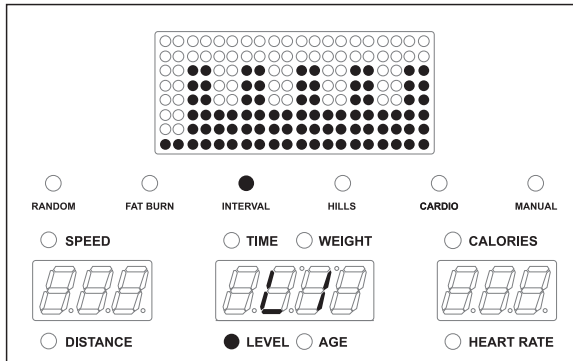

B.Setup the "LEVEL"

*Setup the same way as in the Manual program. (on pages 8 and 9).

Press " ENTER " .

C.Setup the "TIME " , * , Press " ENTER " .

D.Setup the " WEIGHT " , * , Press " ENTER " .

E.Setup the " AGE " , * , Press " ENTER " .

F.The Main Readout will scroll "PRESS START".

Press "  " button, to start the program.

G.You can still adjust the level with the "  " button.

FAT BURN

6.FAT BURN program:

This program does just what the name suggests -gets your heart rate up fast and maintains it at 65% of your calculated maximum heart rate with slight variations to provide optimal calorie burn.

A.Press "  " button (" FAT BURN " light will go on).

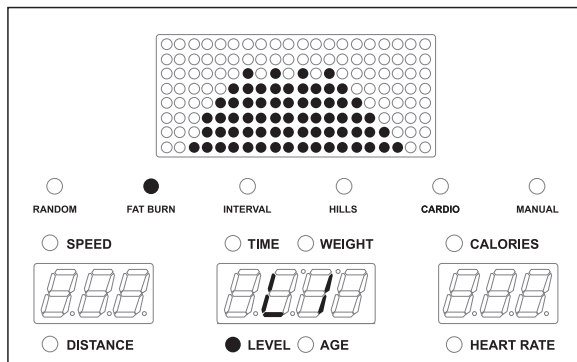

B.Setup the "LEVEL"

*Setup the same way as in the Manual program. (on pages 8 and 9).

Press " ENTER " .

C.Setup the "TIME " , * , Press " ENTER " .

D.Setup the " WEIGHT " , * , Press " ENTER " .

E.Setup the " AGE " , * , Press " ENTER " .

F.The Main Readout will scroll "PRESS START".

Press "  " button, to start the program.

G.You can still adjust the level with the "  " button.

7.RANDOM program:

This program provides different combinations of increased and decreased resistance designed to motivate and challenge. Each time this program is selected, the computer generates a new course.

A. Press "  " button (" RANDOM " light will go on).

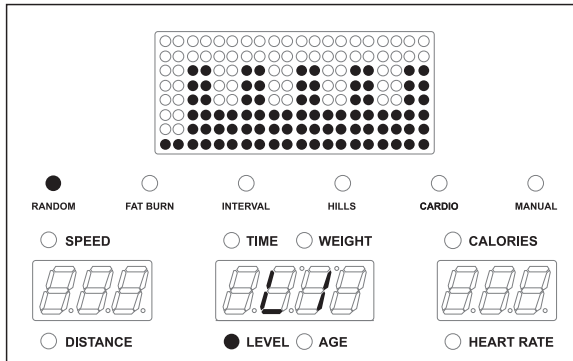

B.Setup the "LEVEL"

*Setup the same way as in the Manual program. (on pages 8 and 9).

Press " ENTER " .

C.Setup the "TIME " , * , Press " ENTER " .

D.Setup the " WEIGHT " , * , Press " ENTER " .

E.Setup the " AGE " , * , Press " ENTER " .

F.The Main Readout will scroll "PRESS START".

Press "  " button, to start the program.

G.You can still adjust the level with the "  " button.

TARGET HEART RATE ZONE

Your Target Heart Rate Zone is a percentage of your maximum heart rate. Target Zone will vary for each individual, depending on age, current level of conditioning, and personal fitness goals. The American College of Sports Medicine recommends working-out at a Target Heart Rate Zone of between 60% of maximum heart rate. See the chart below for convenient reference.

EXAMPLE:

For a 35-year old user: find AGE along the bottom of the chart, follow the AGE column up to TARGET ZONE bar. RESULTS: 60% of maximum Heart Rate = 111 Beats per Minute, 75% of maximum Heart Rate = 139 Beats per Minute. With this Target Zone of 111-139 Beats per Minute it is best to enter an average Target Heart Rate of about 118 Beats per Minute into the Console.

HEART RATE TRAINING ZONE							
MAX	BEATS PER MINUTE						
85%	170	161	153	144	136	128	
70%	140	133	126	119	112	105	
60%	120	114	108	102	96	90	
AGE	20	30	40	50	60	70	

BENEFITS

- **Weight Loss**-Helps you maintain an optimum exercise level to burn fat.
- **Efficient**-Quantifies your exercise level for maximum benefit.
- **Time Saver**-Makes the most of your limited workout time.
- **Motivation**-Provides encouragement to achieve your fitness goals and reach for new heights.

WARNING

Consult your physician to determine your target heart rate before using the heart rate control mode of this product!

The above chart is to be used only as an average reference point and is in **NO WAY** a recommendation of your personal abilities!

Medications may affect your heart rate. Consult your physician for specific advice before exercising.

Do not use this product if you have an acute illness, cold or fever.

STOP EXERCISING IF ANY OF THE FOLLOWING OCCURE:

- **YOU FEEL FAINT OR DIZZY**
- **YOU EXCEED YOUR MAXIMUM HEART RATE AS SET BY YOUR PHYSICIAN.**

LIMITED HOME USE WARRANTY

ENDURANCE is proud to offer you the following warranty, which applies to home use residential, non-commercial purposes only. Any other use of the device will void this warranty.

ENDURANCE hereby extends the following limited warranties for the following components of the device, for the period indicated:

FRAME- LIFETIME ENDURANCE warrants the frame against defects in workmanship and materials for the life of the product, so long as it remains in the possession of the original owner.

Braking System

Electronics & Parts -3 years. ENDURANCE warrants the Electronic Components and all original Parts against defects in workmanship and materials for a period of three years from the date of original purchase, so long as the device remains in the possession of the original owner.

Labor-1 year. ENDURANCE shall cover the Labor Cost for the repair of the device for a period of 1 year from the date of original purchase, so long as the device remains in the possession of the original owner.

LIMITED LIGHT COMMERCIAL WARRANTY

Up to 4 hours use per day

LIGHT COMMERCIAL USES DEFINED ENDURANCE warrants models For use in light commercial facilities including: Hotels, Resorts, Police & Fire Stations, Apartment Complexes, Corporate Fitness Centers, Hospitals, Rehabilitation and Sports Medicine Clinics, where average use is up to five hours per day. Not warranted for private Health Clubs, YMCA's or Schools.

FRAME, BRAKE, ELECTRONICS & PARTS - 2 years ENDURANCE FITNESS warrants the frame, Magnetic Brake, Electronic components and all original Parts against defects in workmanship and materials for a period of 2 years from the date of original purchase, so long as the device remains in the possession of the original owner.

LABOR - 1 year ENDURANCE shall cover the Labor cost for the repair of the device for a period of 1 year from the date of original owner.

EXCLUSIVE REMEDY

The exclusive remedy for any of the above warranties shall be repair or replacement of defective Parts, or the supply of Labor to cure any defect, provided that Labor shall be limited to two years. The local retailer shall supply all labor and the product must be located within that retailer's service area. Products located outside the retailer's service area will not be covered by the labor warranty

Warm Up:

Warming up is an extremely important phase, but unfortunately, it's often an activity that is ignored and painful, frustrating muscle pulls or strains may be the result. There are two goals for warm - up: warming up the muscles of the back and the extremities (so that you can stretch them without injury), and slight acceleration of the heart rate so the body can move gradually into the target heart rate.

Warm - ups should consist of 5-10 minutes of exercises that are not very demanding: marching in place, stepping side to side and swinging your arms walking at a pace of about 3.5mph, ect. (your heart rate should be between 90 - 120.

A gradual warm - up will do the following:

Produce faster more forceful muscle contractions.

Increase your metabolic rate so oxygen is delivered to the working muscles more quickly.

Leads to efficient calorie burning by increasing your core body temperature Prevent injuries by improving the elasticity of your muscles.

Allow you to work out comfortable longer because your energy systems are able to exercise, preventing the buildup of lactic acid in the blood.

Improves joint range of motion.

Psychologically prepares you for higher intensities by increasing your arousal and focus on exercise.

Warm - up : Warm - up 5 to 10 minutes before aerobic activity.

Duration : Maintain your exercise intensity for 20 to 60 minutes.

Cool Down : Gradually decrease the intensity of your workout, then stretch to cool down during the last 5 to10 minutes.

NOTE : If weight loss is your major goal, a minimum of 30 minutes of aerobic activity five or more times per week is recommended.

Up to 4 hours use per day

EXCLUSIONS AND LIMITATIONS

This warranty applies only to the original owner and is not transferable. This warranty is expressly limited to the repair or replacement of a defective Frame, Magnetic Brake, Electronic component, or defective Part and is the sole remedy of the warranty. The warranty does not cover normal wear and tear, improper assembly or maintenance, or installation or parts or accessories not originally intended or compatible with the Fitness Product as sold. The warranty does not apply to damage or failure due to accident, abuse, corrosion, discoloration of paint or plastic, or neglect, or its vendors may sometimes be supplied as warranty replacement parts and constitute fulfillment of warranty terms. Any warranty replacement parts shall be warranted for the remainder of the original warranty term. Expressly disclaims all other warranties, express or implied, including but not limited to all warranties of fitness for a particular purpose or of merchantability. This warranty gives you specific legal rights and your rights may vary from state to state

WARRANTY REGISTRATION

Your warranty card must be completed and sent to Steelflex BEFORE A WARRANTY CLAIM CAN BE PROCESSED.

You may also register via our website at Inside the enclosed warranty card you will find a customer survey. Your care in completing the survey will be of value to us in serving you in the future. Comments and suggestions are always welcome. We are certain you will enjoy your new ENDURANCE Product. Thank you for selecting a ENDURANCE Product.

FLEXIBILITY

Adequate flexibility is the ability to move your limbs and joints easily (through a complete range of motion) the way you need to in order to meet the challenges of daily life. Fortunately there is a positive reinforcing cycle between flexibility and activity. Adequate flexibility enables you to maintain an active lifestyle, and an active lifestyle makes an important contribution to maintaining adequate flexibility. These relationships grow stronger the older we become.

When should I stretch?

Any time is a good time to stretch. In the morning it can work out the kinks in your back, at work, you can relax your neck and shoulders, and after work stretch out your lower back. However, you should never do your stretches before you have had a chance to warm your body up.

How should I stretch?

Perform the following stretches slowly and smoothly until you feel a slight tugging sensation on the muscles involved. Don't stretch to the point you feel pain, and don't bounce you could pull a muscle. Hold each stretch for 10 to 20 seconds. Exhale through the stretch, and breathe slowly. This will keep you from bouncing.

1. Calf (back of lower leg)

- a. Straight knee start with the leg to be stretched approximately three feet from the wall and the opposite leg on step forward. Lean toward the wall, keeping your heels down and feet turned in slightly.
- b. Bent knee start same as above, but move approximately one foot closer to the wall and bend the knee of the back leg to be stretched.
- c. Repeat using the other leg.

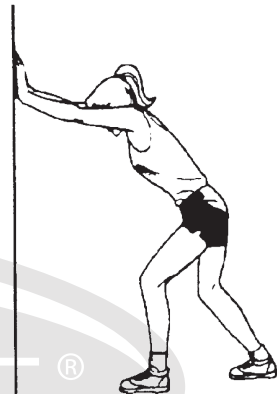
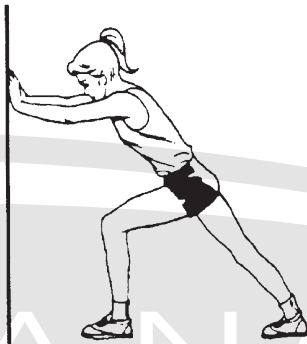

2. Iliotibial Band (outside of hip)

- a. Start with the leg to be stretched one step back and behind the opposite foot. Move your hips sideways toward the side of your body being stretched. Keep the upper body away from the wall and do not bend forward.
- b. Repeat using the other leg.

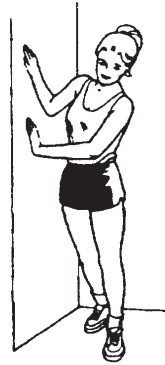

3. Lower Back, Hips, Groin, and Hamstrings

- a. Stand with the feet about shoulder-width apart and pointed straight ahead. If you are pretty flexible and need more of a stretch, cross one leg in front of the other for a few stretches, then switch legs.
- b. Slowly bend forward from the hips, always keeping your knees slightly bent.
- c. Stretch only to the point where you feel a tugging in the back of your legs.

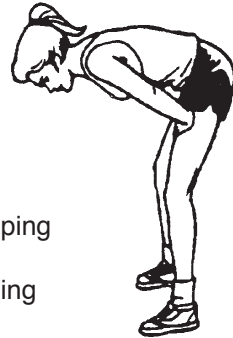

4. Side Bends

- a. Stand with your feet about shoulder-width apart and toes pointed straight ahead. Keep your knees slightly bent, one hand on your hip; extend your other arm up and over your head. Slowly bend at your waist to one side, toward the hand on your hip.
- b. Extend both arms overhead. Hold your right hand with your left hand and bend slowly to the left, using your left arm to pull the right arm gently over the head and down toward the ground.
- c. Repeat with other side.

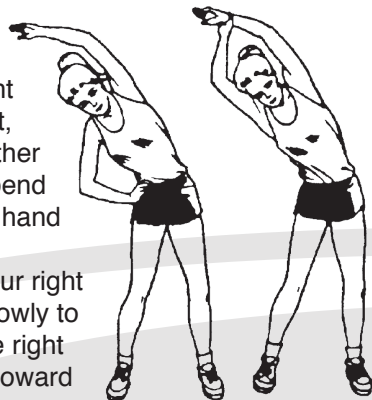

5. Quadriceps (front of thigh)

- Lying on our stomach, pull the heel toward your buttocks with the opposite hand. Keep the thigh of the leg being stretched close to the leg on the floor.
- The same stretch can be done standing. Do not allow the thigh to come in front of you and so not bend forward at the waist.
- Do this exercise twice - once on each leg.

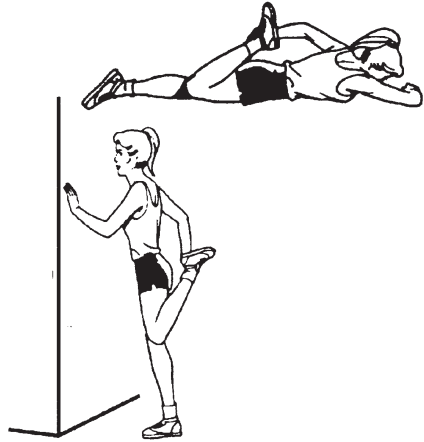

6. Groin (inside of thigh)

- Sit on the floor with the soles of your feet together. Gently push knees down toward the floor with your elbows.
- Stand with your feet three to four feet apart and turned out slightly. Keep the knee of the leg to be stretched straight, and bend the opposite knee as you move your body toward the bent leg. Keep your toes pointed forward.
- Repeat using the other leg.

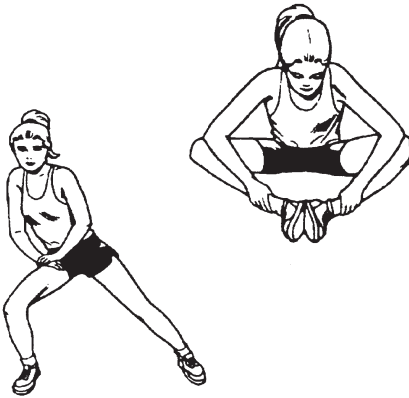

7. Hamstrings (back side of upper leg)

- Sit with one knee bent and the leg to be stretched out straight. Reach for the toes of the straight leg with the right hand and then the left hand.
- Repeat with the other leg.



8. Gluteus (back of hip)

- Lie on your back. Pull one knee up to your chest while keeping the opposite leg down on the floor with the knee straight.
- The same may be done standing.
- Repeat with the other leg.

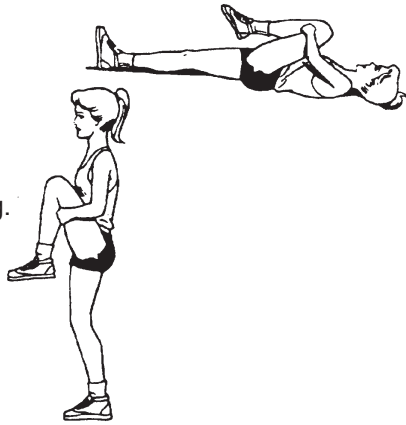

9. Anterior Tibialis (front of shin)

- Stand with all of your weight on one leg. Extend the opposite leg forward and flex and point at the ankle.
- Repeat with the other leg.

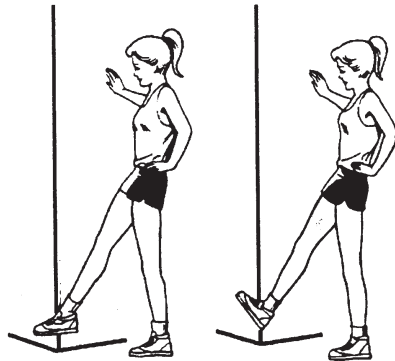

10. Iliopsoas (lower back)

- If you have a neck problem, be very careful with this stretch. In a sitting position (on a mat or rug) hold your knees with your hands and pull them to your chest.
- Gently roll up and down your spine, keeping your chin down toward your chest. This will further stretch the muscles along the spine.
- Try to roll evenly and with control. Roll back and forth 4 to 8 times or until you feel your back loosen.

EXERCISE GUIDELINES

The American Council of Sports Medicine (ACSM) recommends the following exercise guidelines, for healthy aerobic activity:

Warm - up : Warm - up 5 to 10 minutes before aerobic activity.

Duration : Maintain your exercise intensity for 20 to 60 minutes.

Cool Down : Gradually decrease the intensity of your workout, then stretch to cool down during the last 5 to 10 minutes.

NOTE: If weight loss is your major goal, a minimum of 30 minutes of aerobic activity five or more times per week is recommended.

Determining your target heart rate (Kavvonen Heart Rate Formula)

Example: 40 year old with a resting rate pulse of 60 BPM

$220 - 40 (\text{age}) = 180$

$180 - 60 (\text{resting pulse}) = 120$

$120 \times .5 (50\% \text{ intensity}) = 60$

$60 + 60 (\text{resting pulse}) = 120 (\text{target heart rate})$

The following chart explains how to determine your target heart rate for varying levels of intensity. The different levels of intensity will help you achieve different objectives.

Training Zones			
Zone	intensity (%MHR)	Goal	Mode
1	50-60%	Improve health and well-being, decrease stress, reduce risk factors,	Very easy, conversational pace.
2	60-70%	Weight management and optimal fat burning	Easy pace, longer duration to build endurance.
3	70-80%	Aerobic fitness,	Faster pace, improve stamina.
4	80-85%	Aerobic / Anaerobic fitness	Increase speed and improve stride.
5	85-100%	Anaerobic fitness for peak performance and competition	Interval runs to increase VO2 MAX, speed, economy, and form.

ACHIEVING YOUR FITNESS GOALS

Each of us are individuals with possibly different fitness goals. It is critical to determine what your goals are when developing a long term fitness program. ENDURANCE FITNESS Products are pleased with your decision in using our quality products to help reach your fitness goals. Below are some benefits of exercising. We have listed these to help in reaching your fitness goals:

- Strengthens heart and lungs
- Increases energy
- Lowers blood pressure
- Increases metabolism
- Prevents diabetes
- Strengthens bones
- Strengthens and tones muscles
- Maintains weight loss
- Improves productivity
- Improves sleep
- Reduces stress
- Improves posture and appearance
- Reduces feelings of depression
- Improves sense of well - being

SAMPLE GOALS

It's important that your goals are well defined and reachable. Put your goals in writing. The more specific you are the easier it will be to keep track of your progress. Setting long term goals are best reached if one incorporates short term goals in order to reach the overall long term goal. The ENDURANCE product console provides you with several readouts that can be used to record your progress. You can track Distance, Calories or Time. Time is the most important and useful of the test functions.

SAMPLE GOALS:

Goal setting is a popular motivational technique. It's important to set goals and reward yourself when initiating a new exercise program because you're attempting to break current patterns and form a new habit. Whether you use this technique or another, make fitness a priority in your life. You can achieve the ultimate reward to yourself: you can establish the exercise habit!

Some sample goals may be:

To strengthen my heart by exercising 30 minutes three days a week.
(Goal Measurement: Exercise Time 90 minutes a week.)

To improve my bodies ability to utilize and burn fat at a higher rate by exercising at a low intensity for 45 minutes per session, 5 days per week.

(Goal Measurement: Exercise Time = 225 per week).

To decrease work other daily stress by exercising for 20 minutes a day on work days.

(Goal Mesurement: Exercise Time = 100 minutes per week).

KEEPING AN EXERCISE Diary

Feel free to photocopy the following weekly and annual log sheet. By doing so you can pridefully check and return to look at the progress you have made.

DIARY

Week #

Date: _____

Number hours of sleep: _____

Weekly Goals: _____

Scheduled work out time: _____

Reward: _____

Level of intensity by % of your predicted maximal heart rate:

<i>Day</i>	<i>Date</i>	<i>Workload Level</i>	<i>Exercise Time</i>	<i>Distance</i>
Sunday				
Monday				
Tuesday				
Wednesday				
Thursday				
Friday				
Saturday				
Totals				

Rating of your perceived exertion (R.P.E., Borg Scale)

6		13	Some What Hard
7	Very, Very Light	14	
8		15	Hard
9	Very Light	16	
10		17	Very Hard
11	Fairly Light	18	
12		19	Very, Very Hard

Photocopy and use on a weekly basis.

HEART RATE CONVERSION FOR 10 SECONDS (USE AS REFERENCE)

11 = 66	19 = 114	27 = 162
12 = 72	20 = 120	28 = 168
13 = 78	21 = 126	29 = 174
14 = 84	22 = 132	30 = 180
15 = 90	23 = 139	31 = 186
16 = 96	24 = 144	32 = 192
17 = 102	25 = 150	33 = 198
18 = 108	26 = 156	34 = 204



Endurance-Warranty Department
1900 S. Des Plaines Ave.
Forest Park, IL 60130
Phone: 1-800-556-3113
Fax: 1-708-427-3598
service@endurancecardio.com

